

HFT Software Update

S. Margetis, KSU

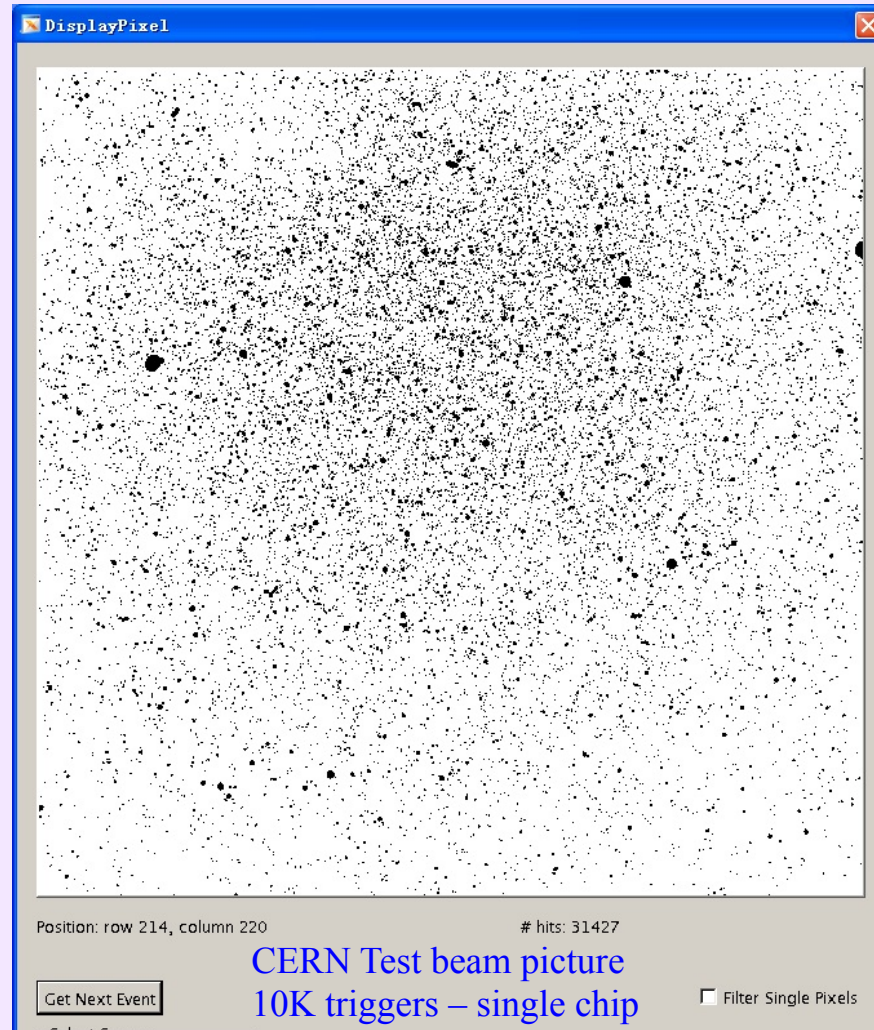

Outline

- Task overview and schedule
- Progress and expected progress for next year(s)
- Issues

Instead of an Introduction

- HFT Software team effort so far concentrated on Physics simulations, CD 0-1-2/3
 - This is over as of about now
 - Physics performance/simulation work moved to HF forum
- The Geometry model/response simulators/tracking/analysis were primitive in those simulations but...The regular chain was used, not shortcuts
- Effort now is aiming at ~Day-1 operational software
 - Online/offline
- Dates that drive the priorities/schedule are
 - *PIXEL prototype* installation in Fall-2012 for Run-13
 - 2-3 PXL re-configurable sectors
 - NO SSD/IST
 - *Full HFT* installation in Fall-2013 for Run-14 data taking

Some clarifications

- HFT Software includes both **Online** and **Offline** effort
 - So far we concentrated on offline tasks/schedule
 - Online is to be delivered by 'hardware' teams but we need to clarify the situation very soon.
 - Online includes: slow controls, data delivery to DAQ, Shift-QA
- "Bad DOE experience" with SVT, divided software (artificially) in two categories:
 - **On-project-scope software activities**. Part of PEP. Managed/monitored by HFT-TC and report to DOE. Includes Online, Survey (calibration and alignment)
 - **The rest**. Monitored (internally) by HFT-TC. Includes Geometry, Response simulators, Hit finders, Tracking, Vertexing, Evaluation, track alignment

WBS task dictionary and schedule has been developed

WBS 1.6 (Software): Schedule (Template)

1.6 Software

The Software deliverables contain all software modules necessary to produce physics results. The tools are divided into two broad categories: Online and Offline. The modules needed will monitor, calibrate, reconstruct, analyze and evaluate acquired data samples.

1.6.1 Online

The online software primarily ensures the data integrity during data acquisition, appropriate detector monitoring and sample event reconstruction. Online software is detector specific and is a deliverable of the corresponding sub-system.

1.6.2 Offline

The offline environment consists of the event reconstruction software packages. This starts with the raw data as input and through proper calibrations it produces detector cluster/hit finding, integrated tracking, event-vertex and secondary vertex finding and event information writing on DSTs.

Hit Reconstruction

The Cluster/Hit finder is the first piece of code applied to the pedestal subtracted raw information from the IST and PXL detectors and its task is to deliver reconstructed space points to tracking software. The software modules associated with this task are outlined below (grouped by detector):

1) SSD: The SSD is an existing (refurbished) detector in STAR. Its behavior is well understood and there are hit reconstruction modules already in place. The only software tasks left are dead-strip mapping (a calibration/Db issue) and the update/testing of the hit finder routine with the new configuration. We also list here an unfinished/untested single-side hit finder as a prospective hit-finder update provided the manpower to finish it.

1.1 Test/Certify/Update the existing SSD cluster/hit finder with the new configuration. 0.5 FTE for a period of 6(2) months is needed for this task completion.

1.2 Test/Evaluate the single-side hit finder based on the Root function TFSpectrum initiated by BNL/Nantes. 0.5 FTE for a period of 6(2) months is needed for this task completion. The deliverable would be a replacement cluster/hit finder for the SSD and perhaps the IST.

Institutions responsible: [KSU, BNL, other]

2) IST: The IST hit finder can either be a modified version of the SSD one (since the

1.6 Software

ID	Task-name	Duration	Begin-Date	Predecessors	Resources ¹
1.6.1	Hit Reconstruction	24 months	09/01/2011		3.0 FTE
1.6.1.1	PIXEL Hit Reconstruction	24 months	09/01/2011		1.5 FTE
1.6.1.1.1	Develop/Test	6 months	09/01/2011	1.6.7.1	
1.6.1.1.2	Evaluate/Tune	4 months	09/01/2011	1.6.7.1	
1.6.1.2	IST Hit Reconstruction	24 months	09/01/2011		0.5 FTE
1.6.1.2.1	Develop/Test/Eval.	6 months	09/01/2012	1.6.7.2	
1.6.1.3	SSD Hit Reconstruction	24 months	09/01/2011		1.0 FTE
1.6.1.3.1	Update/Test/Eval.	6 months	09/01/2012	1.6.7.3	
1.6.2	Tracking	36 months	09/01/2011		2.0-4.0 FTE
1.6.2.1	Update/Test/Evaluate	36 months	09/01/2011	1.6.8/1.6.7.1-3	
1.6.2.2	Alternative Track. Eval.	24 months	06/01/2011	1.6.8/1.6.7.1-3	

¹ See detailed breakdown in Appendix

Task Overview and Institutions (not uptodate)

	Software task		BNL	IPHC	UCLA	KSU	NPI	MIT	LBL	Purdue	USTC
FTEY (50% error)											
	Offline										
2	Hit Reconst.	IST						X			
		Pixel							X	X	
2	Tracking		X	X							
2	Event Vertex		X	X		X	X				
1.5	Decay Vertex		X	X		X	X				X
4.7	Calibration Db	SSD	X			X			X		
		IST	X					X			
		PXL	X						X	X	
2	Alignment	SSD	X			X			X		
		IST	X			X		X			
		PXL	X			X			X	X	
	Simulation										X
1.1	Geometry	SSD	X			X			X		
		IST	X					X			
		PXL	X						X		
0.8	Fast/Slow Sim.	SSD				X			X		
		IST				X		X			
		PXL		X					X	X	
0.5	Embed./Pileup	IST				X		X	X	X	X
	Assoc/Analysis		X			X	X				

Total= 16.6

On-scope Schedule

NOW

Task ID	Task Name	Progress	Duration
1.6	Software	0%	464 days
1.6.1	Online	0%	464 days
1.6.1.1	PXL	0%	251 days
1.6.1.1.1	metrology conversion into hit point software	0%	20 days
1.6.1.1.2	data format unpacker	0%	17 days
1.6.1.1.3	Slow controls integration	0%	40 days
1.6.1.1.4	error condition lookup action implementation	0%	60 days
1.6.1.1.5	plot generation and analysis of status header	0%	60 days
1.6.1.1.6	L3 - PXL online software ready for engineering run	0%	0 days
1.6.1.1.7	Online Software for production PXL	0%	45 days
1.6.1.1.8	L3 - PXL online software ready for production run	0%	0 days
1.6.1.2	IST	0%	284 days
1.6.1.2.1	Data format unpacker	0%	14 days
1.6.1.2.2	Plot generation single ladder	0%	61 days
1.6.1.2.3	Pedestal software	0%	50 days
1.6.1.2.4	Diagnostic software	0%	50 days
1.6.1.2.5	L3-online software ready for ladder tests tests	0%	0 days
1.6.1.2.6	Update software for IST layer	0%	60 days
1.6.1.2.7	L3 - IST Online Software Complete	0%	0 days
1.6.1.3	SSD	0%	195 days
1.6.1.3.1	data format unpacker	0%	25 days
1.6.1.3.2	Create Online Plots	0%	1 mon
1.6.1.3.4	Create, Program and Test Pedestal Algorithm	0%	20 days
1.6.1.3.5	SSD ready to take ladder data	0%	0 days
1.6.1.3.7	update software for complete SSD	0%	30 days
1.6.1.3.8	L3 - SSD Online Software Complete	0%	0 days
1.6.1.4	Calibration and alignment	0%	464 days
1.6.1.4.1	Survey Software	0%	180 days
1.6.1.4.1.2	CMM analysis software development	0%	9 mons
1.6.1.4.1.1	Test and verify	0%	5 mons
1.6.1.4.1.9	Internal Review of CMM survey software progress	0%	0 days
1.6.1.4.5	CMM analysis	0%	318 days
1.6.1.4.5.1	Analysis of PXL	0%	318 days
1.6.1.4.5.1.10	prototype ladder analysis	0%	3 mons
1.6.1.4.5.1.11	Database entry delivered	0%	0 days
1.6.1.4.5.1.12	production ladders	0%	4 mons
1.6.1.4.5.1.13	L3 PXL Database entry delivered	0%	0 days
1.6.1.4.5.2	Analysis of IST	0%	60 days
1.6.1.4.5.2.5	CMM analysis	0%	3 mons
1.6.1.4.5.2.6	L3 IST Database entry delivered	0%	0 days
1.6.1.4.5.3	Analysis of SSD	0%	60 days
1.6.1.4.5.3.1	CMM analysis	0%	3 mons
1.6.1.4.5.3.2	L3 SSD Database entry delivered	0%	0 days
1.6.1.6	Global Alignment	0%	240 days
1.6.1.6.1	Software Development	0%	12 mons
1.6.1.6.2	Testing phase	0%	11 mons
1.6.1.6.3	L3- Alignment prototype software review	0%	0 days
1.6.1.6.4	L3 - Alignment software for Engineering Run	0%	0 days
1.6.1.8	Self Alignment	0%	240 days
1.6.1.8.9	Software Development	0%	12 mons
1.6.1.8.10	Testing phase	0%	11 mons
1.6.1.8.11	L3- Alignment prototype software review	0%	0 days
1.6.1.8.12	L3 - Alignment software for Engineering Run	0%	0 days

CMM analysis software development

Internal Review of CMM survey software progress

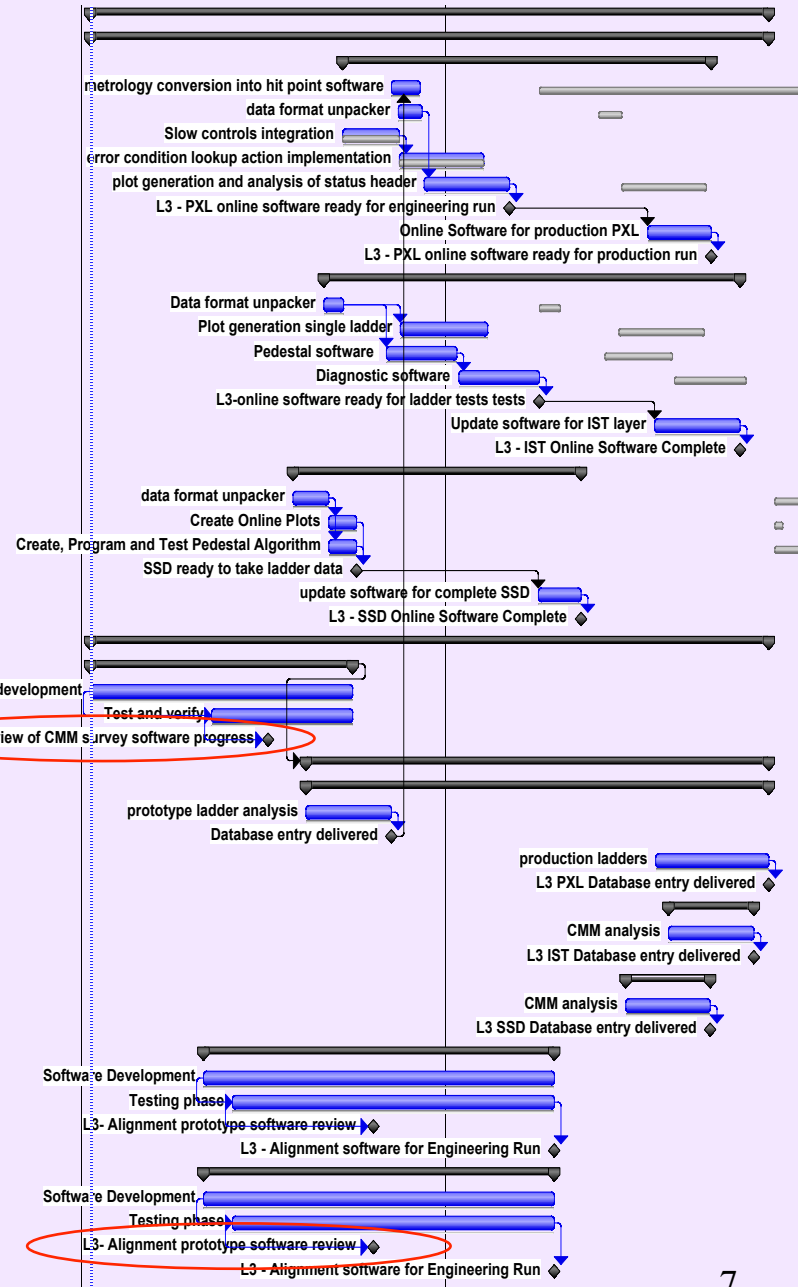

Prioritized list of Tasks for next year

- CMM measurements + related work for PXL fixture and sectors
- Familiar with one CMM machine at LBL
- Scheduled some measurements in the new VIEW-3000 machine
- We are on schedule but it is getting tight
 - Review in April 2012

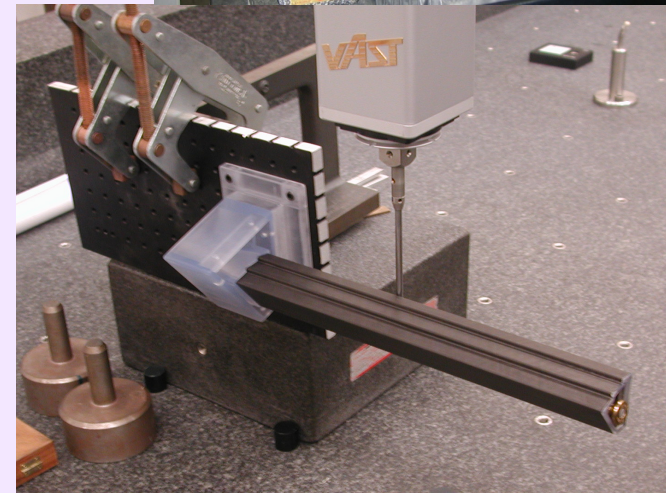
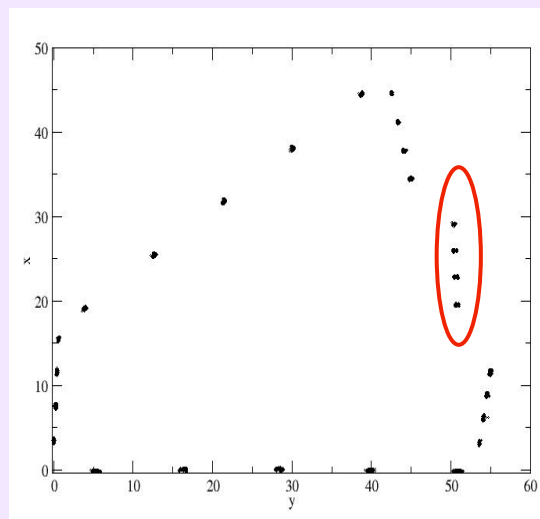
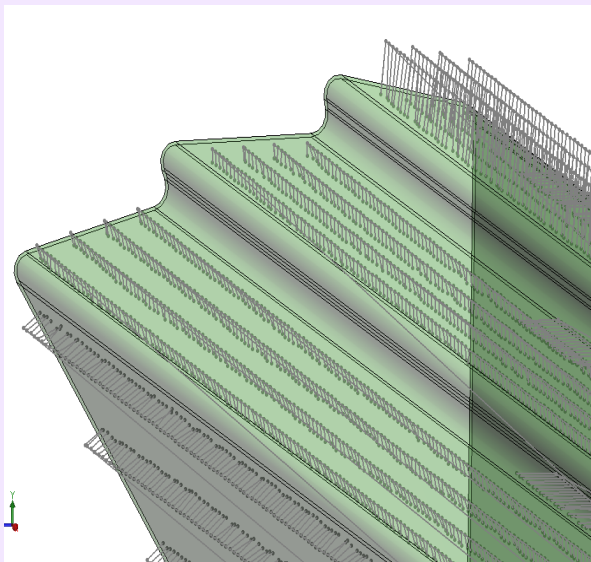
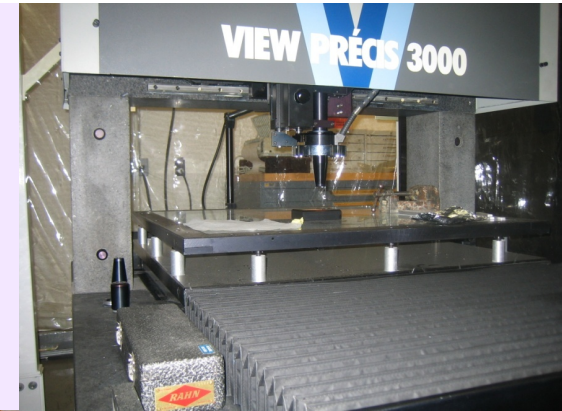
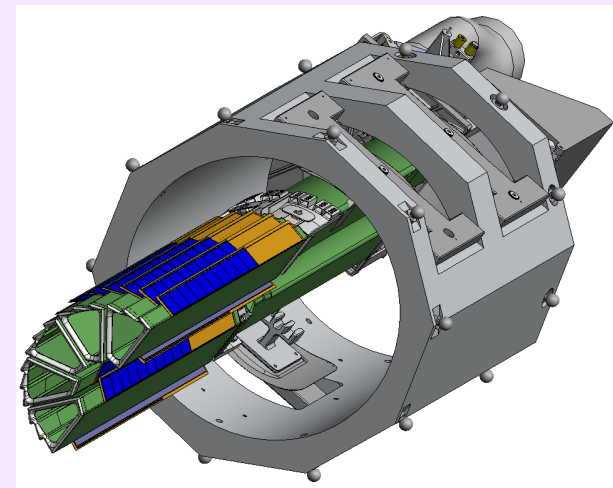

Prioritized list of Tasks for next year

- **HFT Geometry model update**
 - Create Y2013a/b geometries
 - Jason created 'blank' based on Y2012
 - We are gathering info on material for Y2013
 - What, how much XO
 - On schedule but manpower an issue

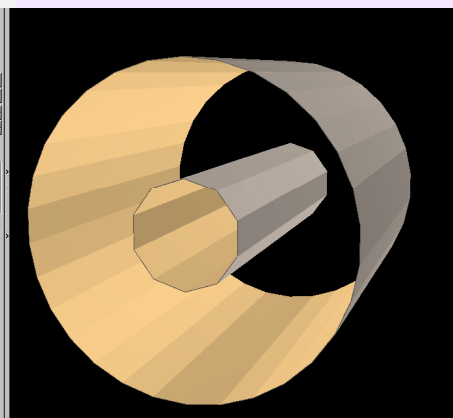
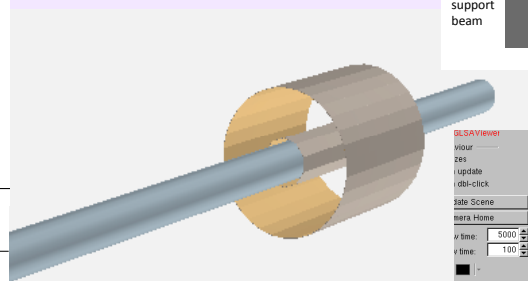
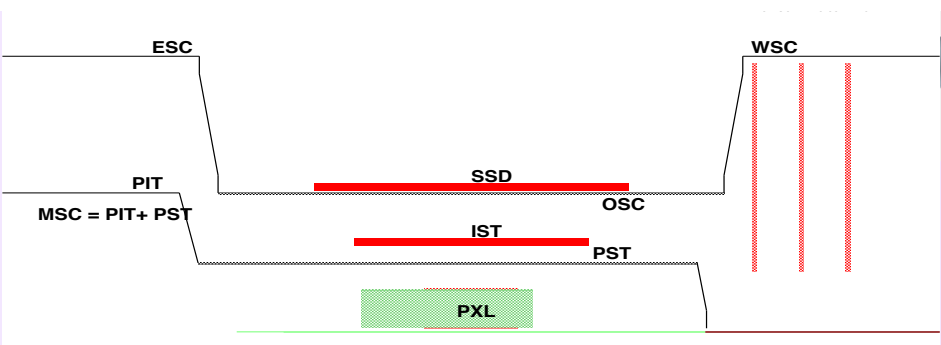
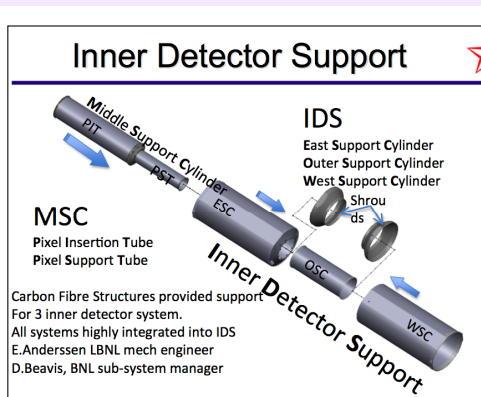
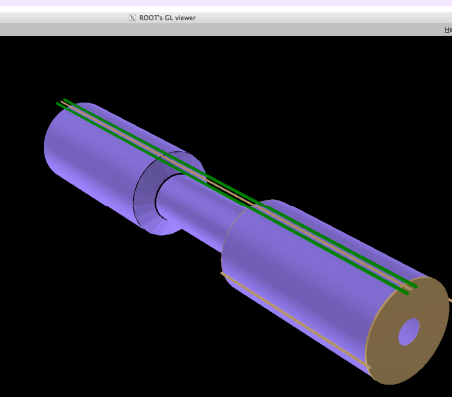
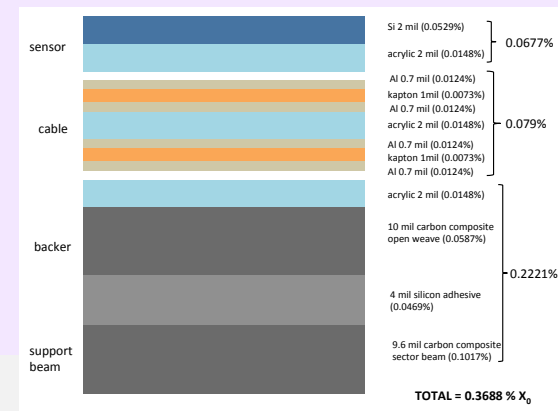
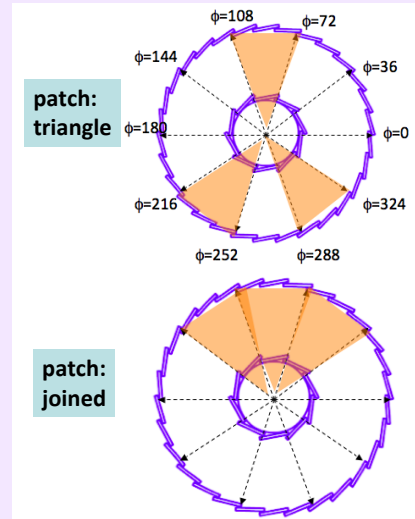

Prioritized list of Tasks for next year

- 'Online' data format/slow controls/online QA/Db considerations
 - Needs to be defined/clarified a.s.a.p.

Prioritized list of Tasks for next year

- **Slow/Fast PXL response simulation**
 - Initial work done earlier by Purdue
 - Initiated contact with IPHC experts during the HFT Software day (9/2011)
 - Got their DIGMAPS code
 - Will collaborate to make an acceptably fast 'slow' simulator for the chain

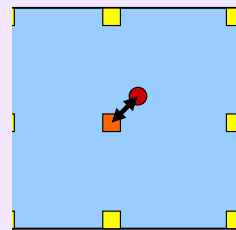
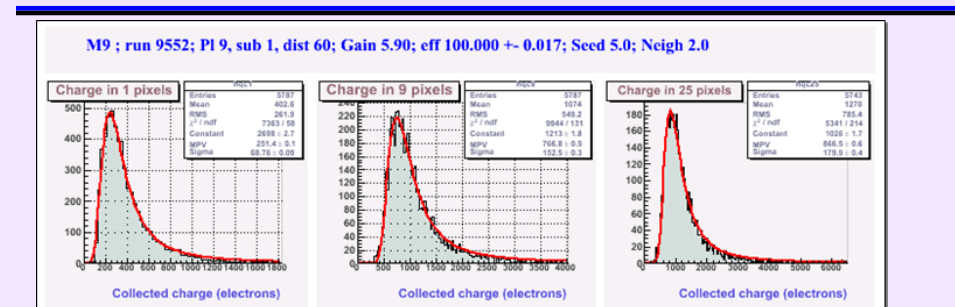
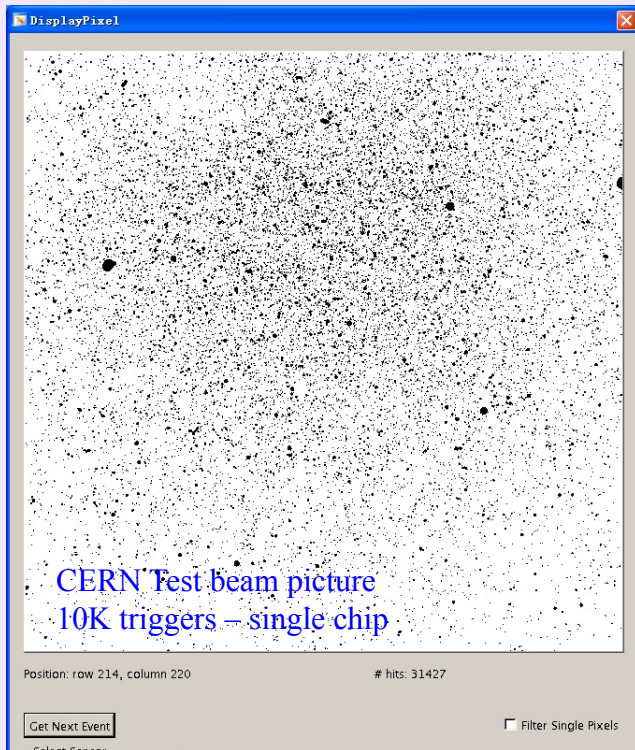

- = Collecting diodes
- = seed diode
- = Impact position
- = seed-impact distance

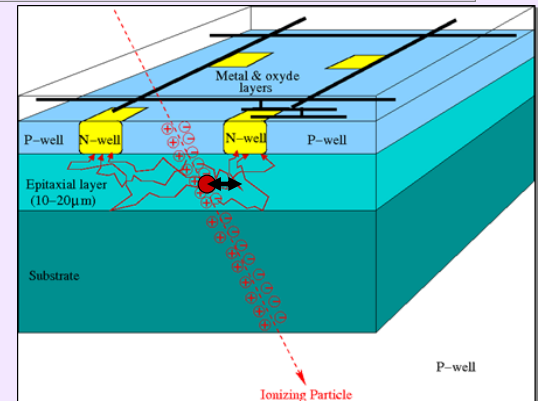

Outlook: implementing a digitizer in HFT-software

- DIGMAPS = Tool under development but allows already many studies:
 - sensor(s)/models with a digitised output
 - any other charge transport model
 - Optimize parametrized models for fast sim
 - Optimize ADCs/discriminators
 - N bits, dynamic range, Noise, etc.
 - clustering algorithms
 - chip occupancy
 - Hit separation performances
 - Zero suppression blocks, etc.
 - Study incident angle effects
 - CPU performances vs models
- HFT simulation (Fast/full simulation)
 - Simulating charge transport can be CPU time consuming
 - You should define which amount of complexity/computing you can afford.
 - A lot of possible algorithms/approaches
 - DIGMAPS can help to decide which precision you want
 - Multiplicity vs incident angle/charge deposition/impact position = difficult to parametrize
 - Nevertheless, building a physical model is out of reach
 - Data driven approach
 - Use test beam data as input/guideline is the key

Prioritized list of Tasks for next year

- **Tracking with TPC+PXL prototype?**
 - Can we do anything substantial here?
 - Any physics with the prototype?
 - Jonathan spends some time on this right now

OtherTasks

- For the next 2 years
 - -----
 - Evaluation/Analysis framework
 - -----
 - Tests/evaluation of new STV tracker
 - Hit reconstruction software
 - Event vertex finder evaluation

Summary

- With CD-x behind us we have established contact with STAR S&C group at the HFT Software day, end of last month
 - I am here as a result of that contact
- We expect an increasing interaction with the BNL-core group
 - Started with Jason on geometry but will expand to all areas
- We are getting our act (and manpower) together