

Software - Draft

S. Margetis, KSU

- General Update
 - Activities since CD2/3
 - Schedule/timeline - Milestones
 - Activities for next calendar year
- Manpower update
- I do assume that Slow Controls are going to be included in the Subsystem slides
- The same goes for Survey progress in PXL, SSD and IST, hardware part with nice pictures.
- If this is not the case then I will put it here

OVERALL FLOW

Software task	
Offline	
Hit Reconst.	IST
	Pixel
Tracking	
Event Vertex	
Decay Vertex	
Calibration Db	SSD
	IST
	PXL
Alignment	SSD
	IST
	PXL
Simulation	
Geometry	SSD
	IST
	PXL
Fast/Slow Sim.	SSD
	IST
	PXL
Embed./Pileup	IST
Assoc/Analysis	

- Here I plan to put a flow chart of Software tasks like the list on the left but with boxes etc

Areas of activities since CD2/3

- HFT Geometry model
- HFT Survey - software related work
- Slow/Fast PXL response simulation
- Prototype (BUR) simulations/tracking
- Offline structures
- Simulation environment (UPC e^- background, Pileup)
- Conventions (naming revisited)

-
- Evaluation/Analysis framework
 - Tests of new STV tracker, VMC environment
 - Event vertex finders/Kalman fitter for decays
 - Web docs
 - 'Online' data format/slow controls/online QA/Db considerations

- **HFT Geometry model update**
 - Create Y2013a/b geometries
 -

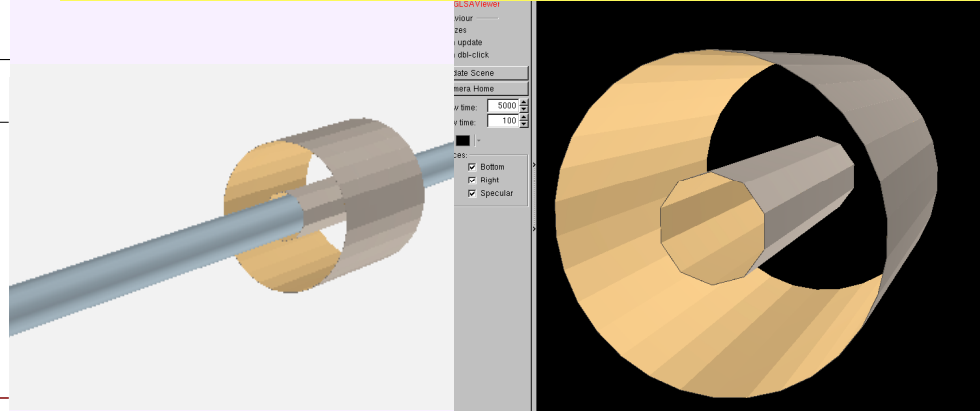
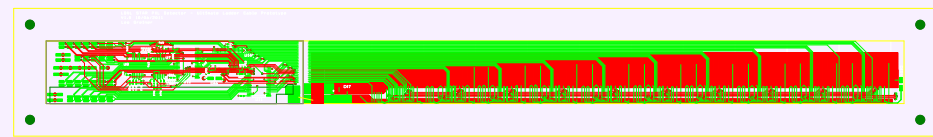
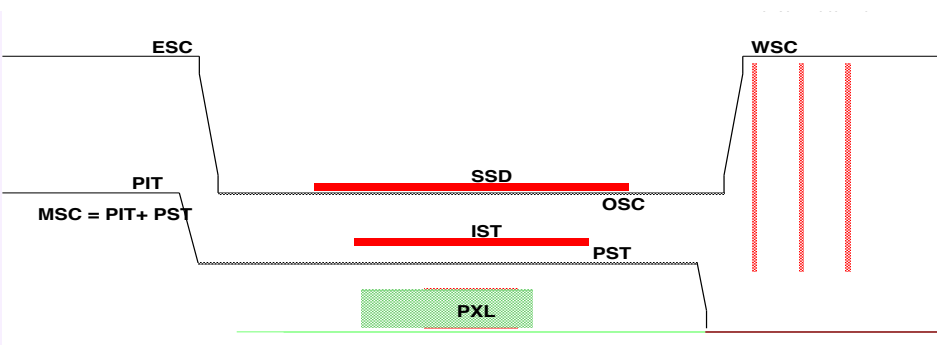
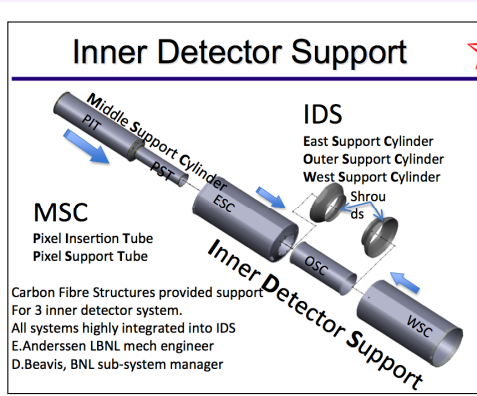
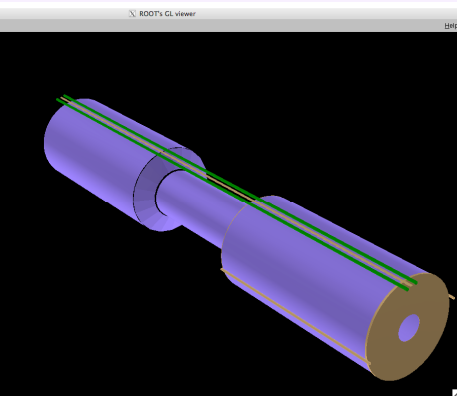
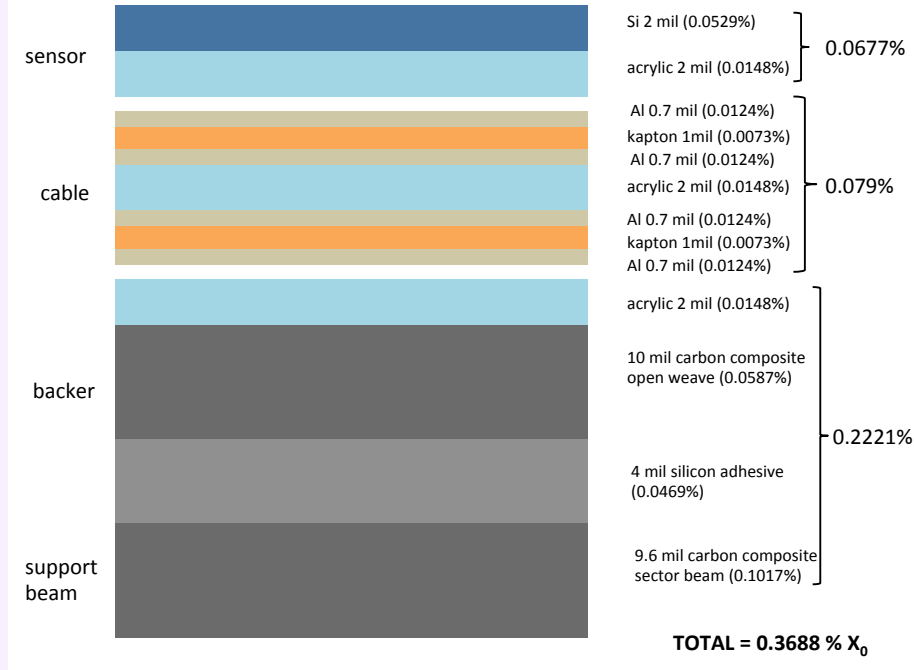

SUMMARY OF MATERIAL BUDGET

GEANT NAME	piece	shape	Composition / mixture	Radiation length [cm]	Density[g/cm ³]
PLAC	Silicon active	box	Si	9.36	2.33
SIFR	Silicon passive	box	Si	9.36	2.33
SIFL	Silicon passive	box	Si	9.36	2.33
GLUA	adhesive	box	O(0.164) C(0.763) H(0.073)	34.7	1.2(*)
GLUB	adhesive	box	O(0.164) C(0.763) H(0.073)	34.7	1.2(*)
GLUC	adhesive	box	O(0.164) C(0.763) H(0.073)	34.7	1.2(*)
ALCA	Aluminum cable	box	Al	23.7(*)	2.7(*)
CBFK	Carbon Fiber backing	box	C	68(*)	1.3(*)

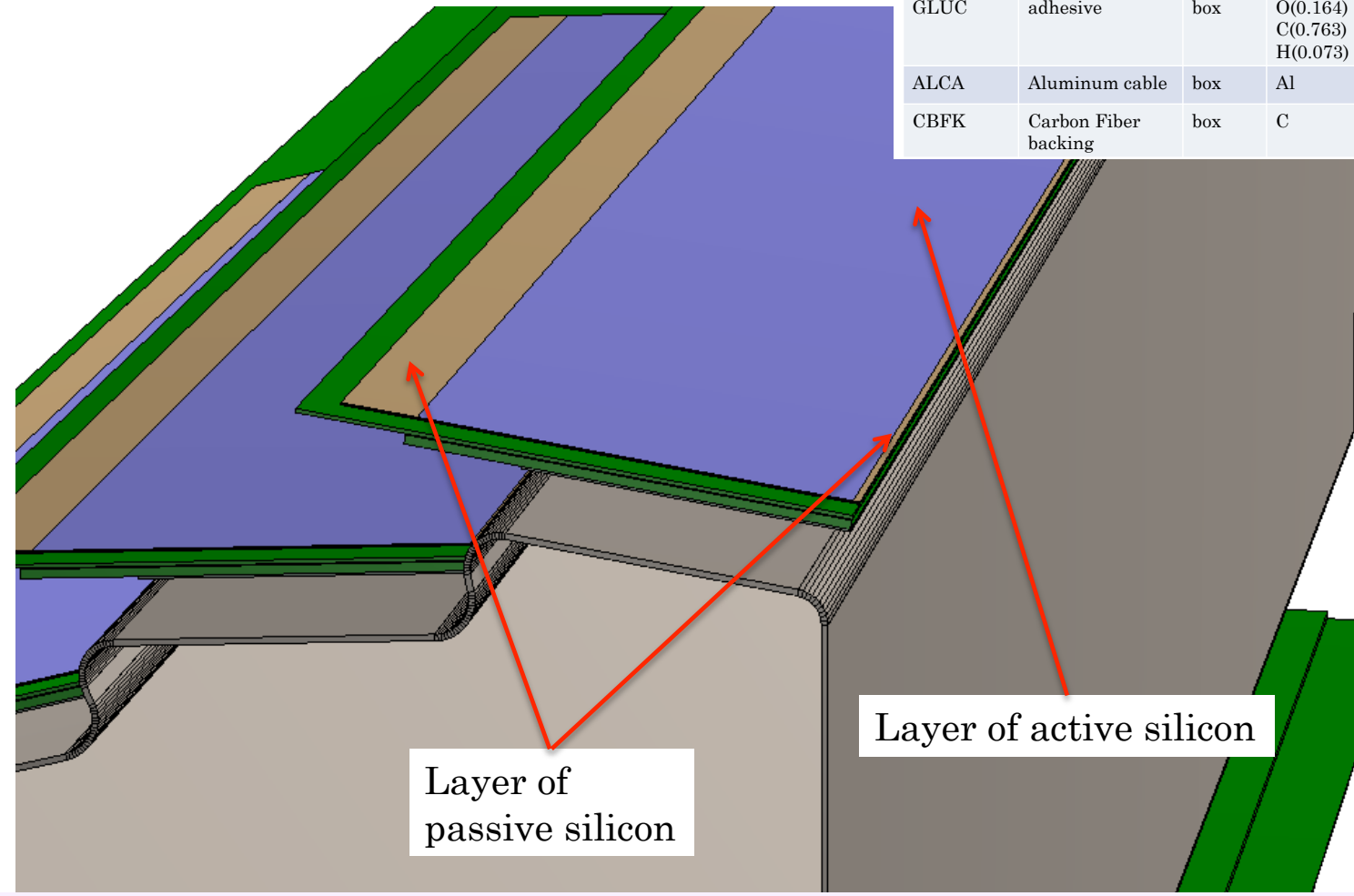

Layer of passive silicon

Layer of active silicon

OVERVIEW OF THE MSC

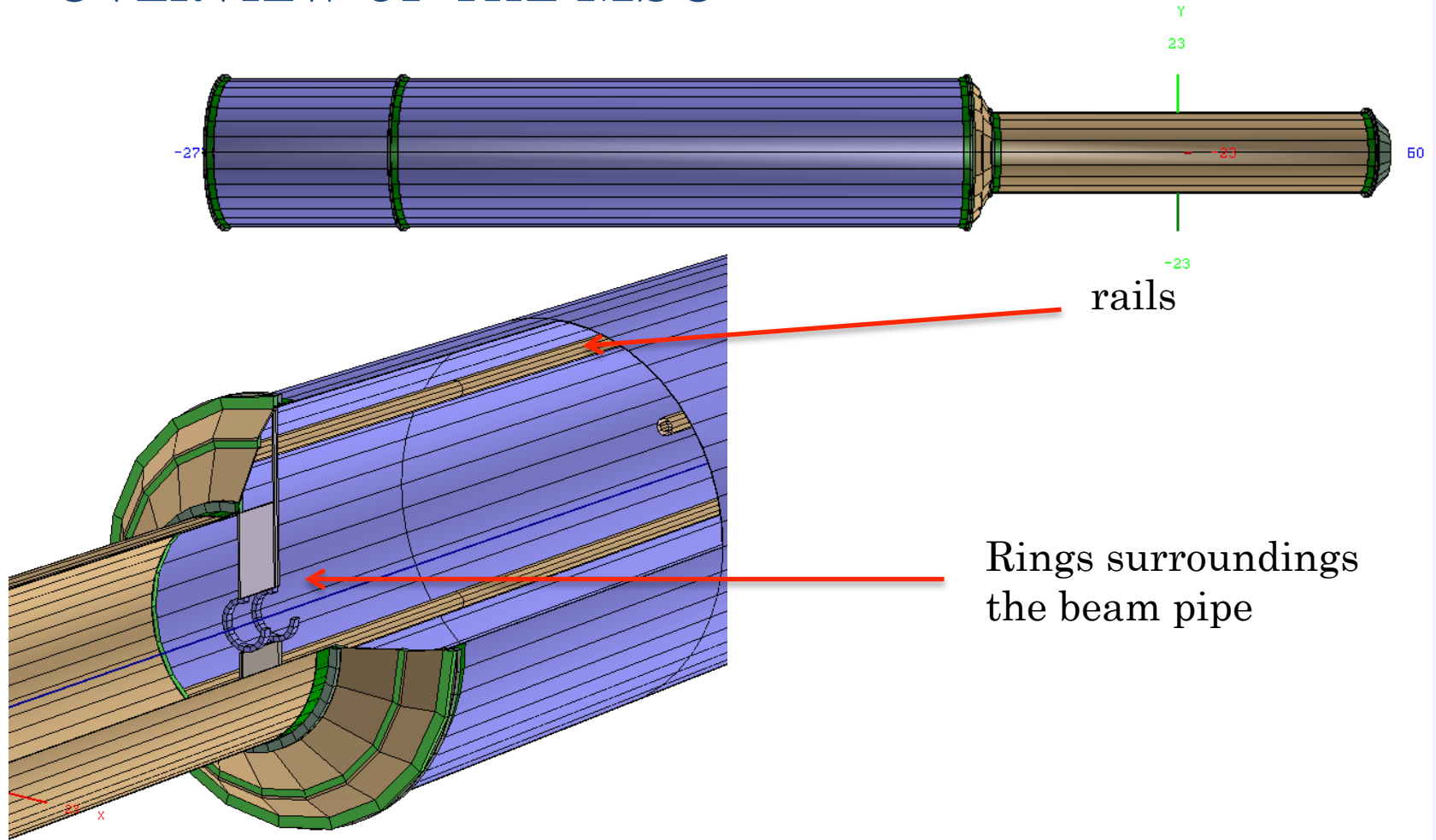

•: temporary until implementation of real material (slide 39)

GEANT NAME	piece	Composition / mixture	Radiation length	density
ALL(*)	Carbon Fiber	C	23.9	1.3(*)

- **HFT Survey work**
 - PXL+SSD work has already begun
 -

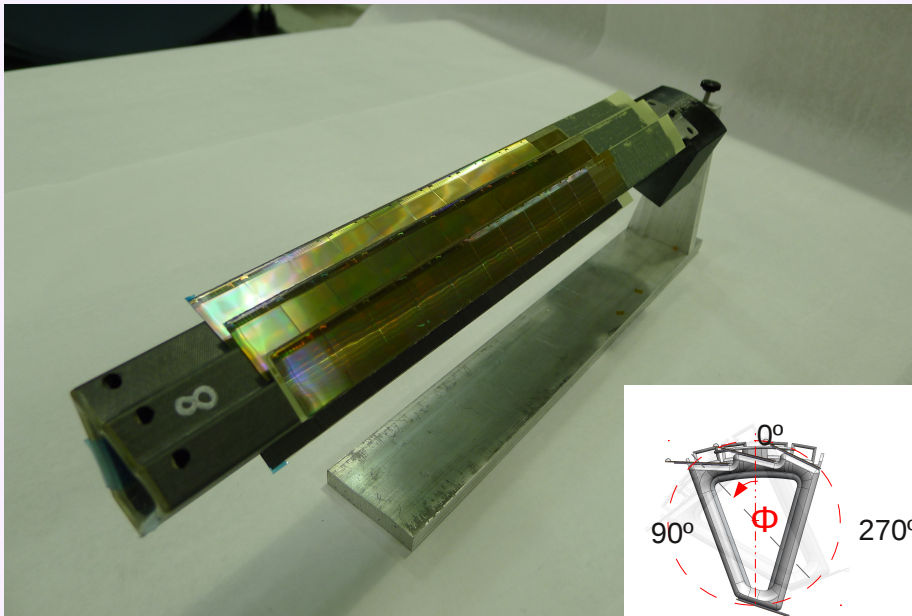

Difference from plane

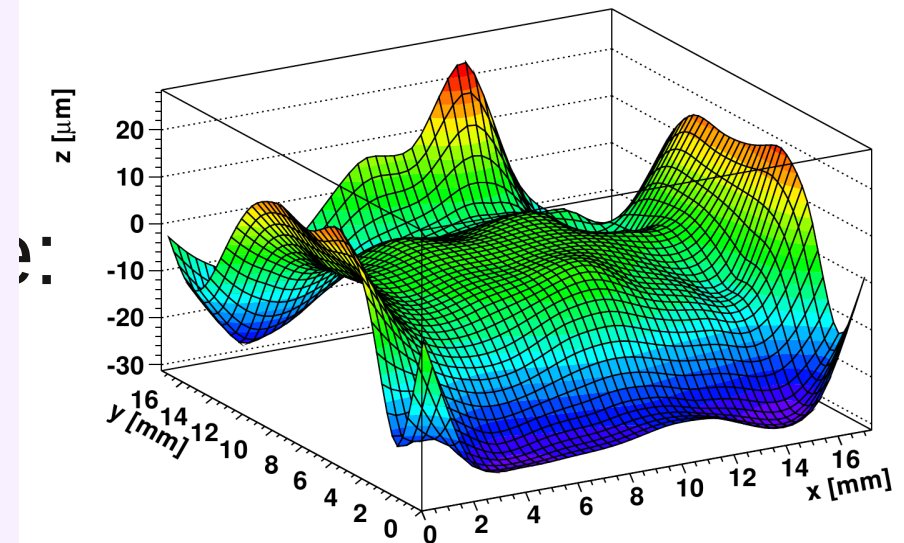

$x=4594.225 \mu\text{m}$
 $y=10000.00 \mu\text{m}$
 $z=0 \mu\text{m}$

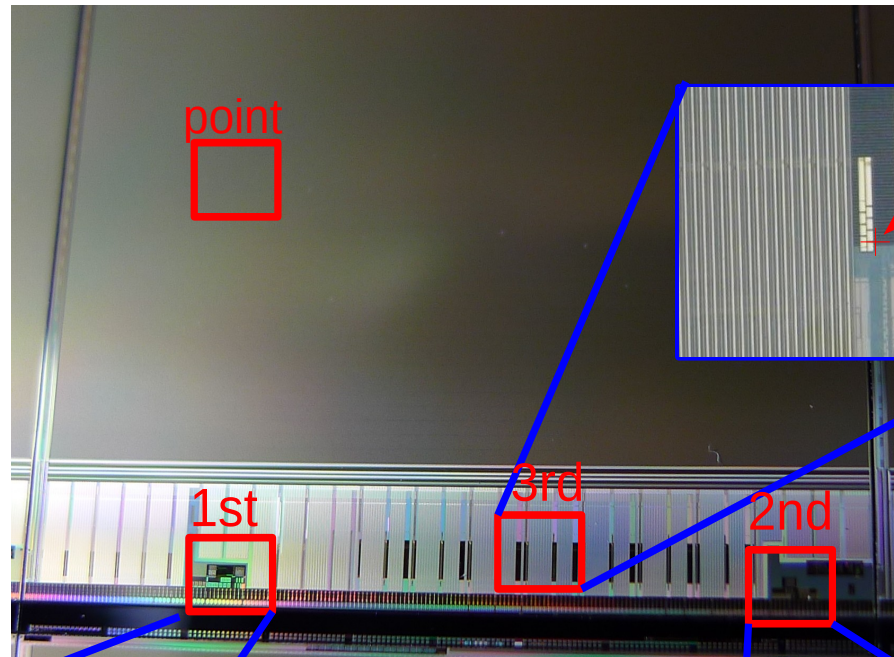

point

$x=? \mu\text{m}$
 $y=? \mu\text{m}$
 $z=0 \mu\text{m}$

1st

3rd

2nd

$x=4594.225 \mu\text{m}$
 $y=920.775 \mu\text{m}$
 $z=0 \mu\text{m}$



$x=18165.075 \mu\text{m}$
 $y=871.6 \mu\text{m}$
 $z=0 \mu\text{m}$

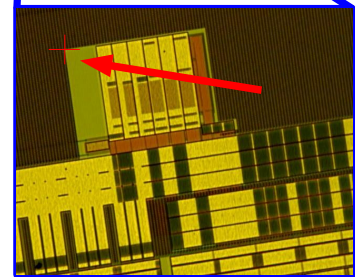

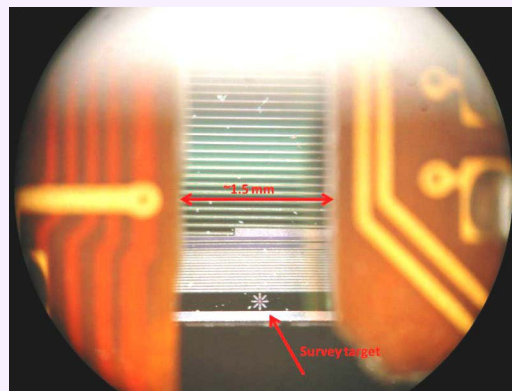
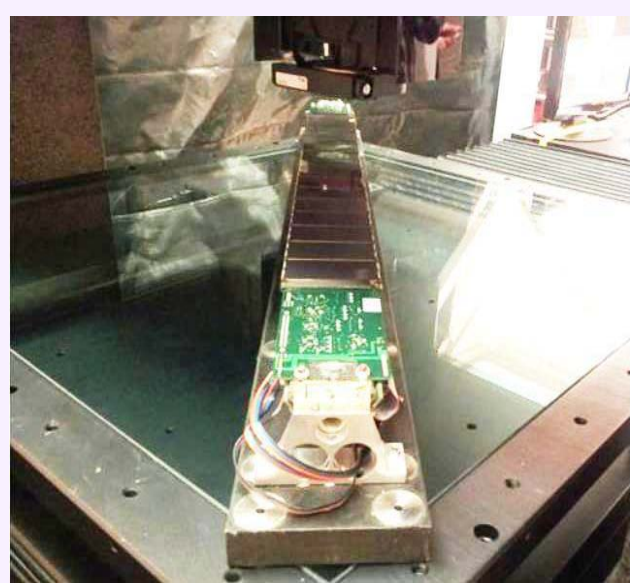

Target on end of wafer (backside)

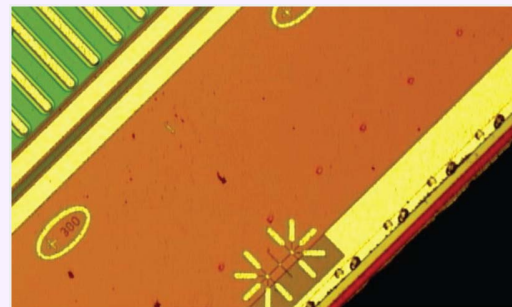

Targets on edges of wafer (front)

Reference point

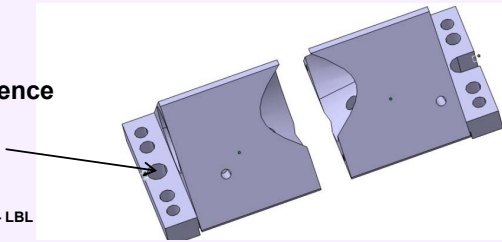

Jim Thomas - LBL

SSD

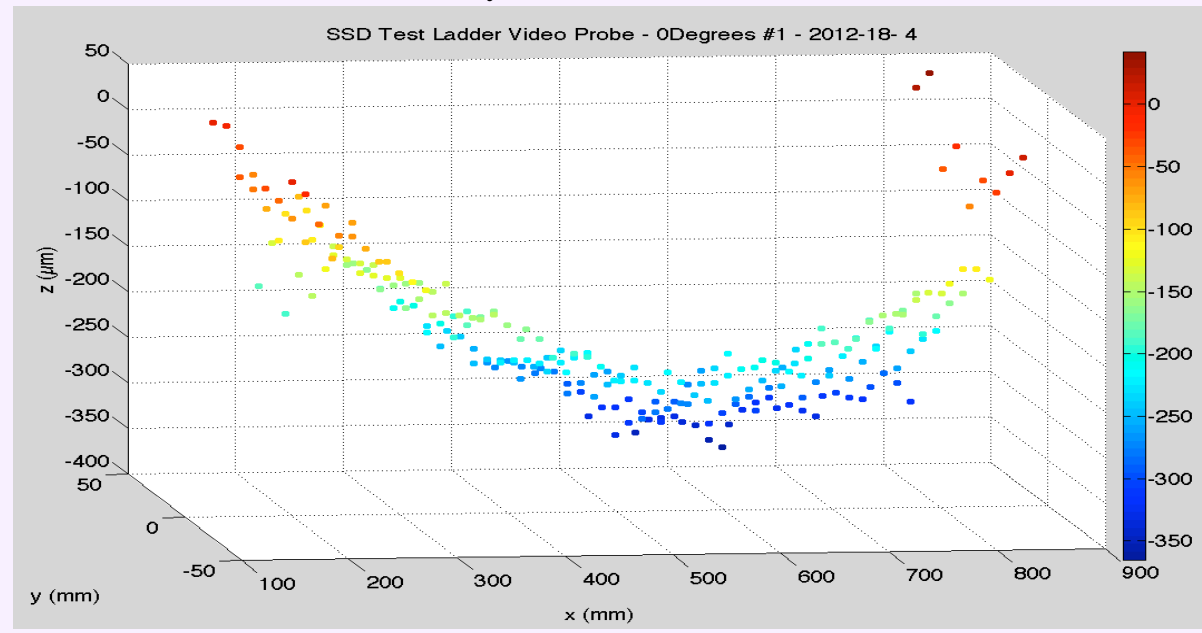

- Slow/Fast PXL response simulation

- ...

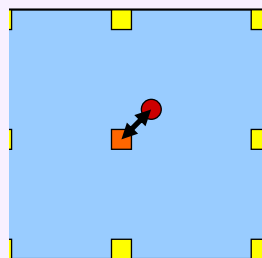
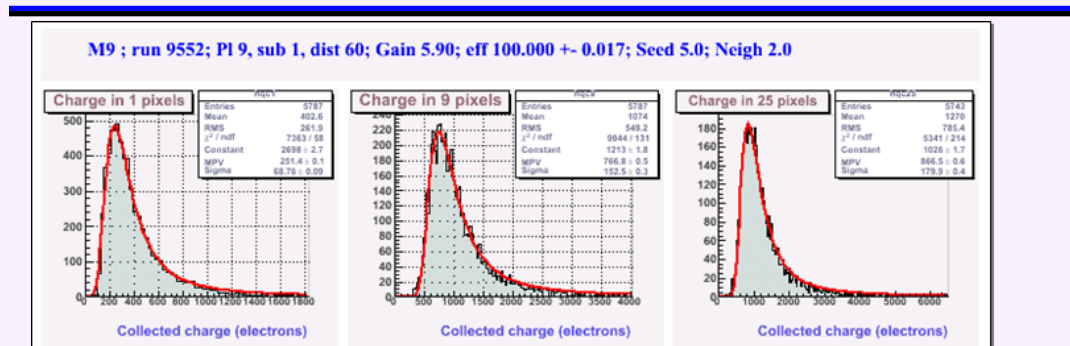

- | = Collecting diodes
- | = seed diode
-) = Impact position
- ' = seed-impact distance

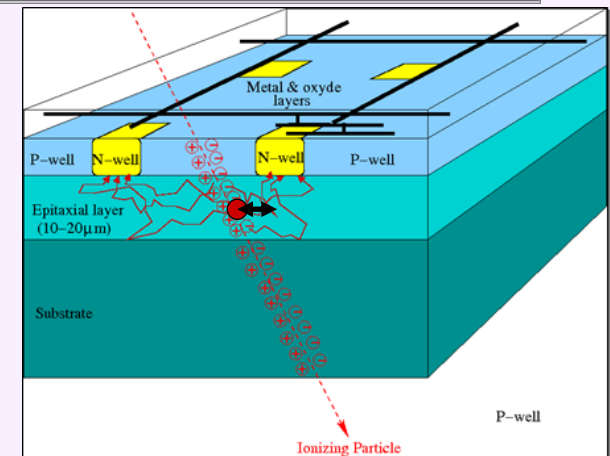

Misc

- Prototype (BUR) simulations/tracking
- Offline structures
- Simulation environment (UPC e^- background, Pileup mechanism)
- Tests of new STV tracker, VMC environment
- Event vertex finders
- Web Docs

- Tracking with TPC+PXL prototype?

- ...

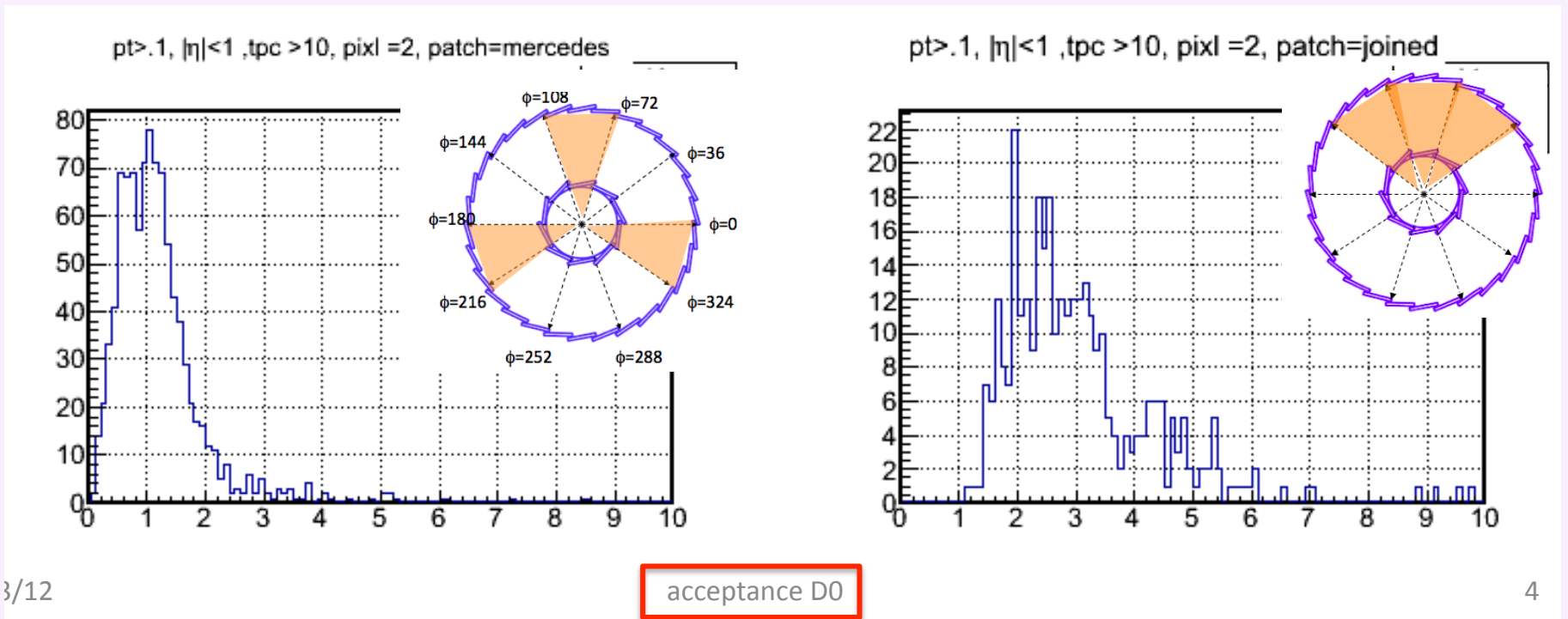

Hao's results here

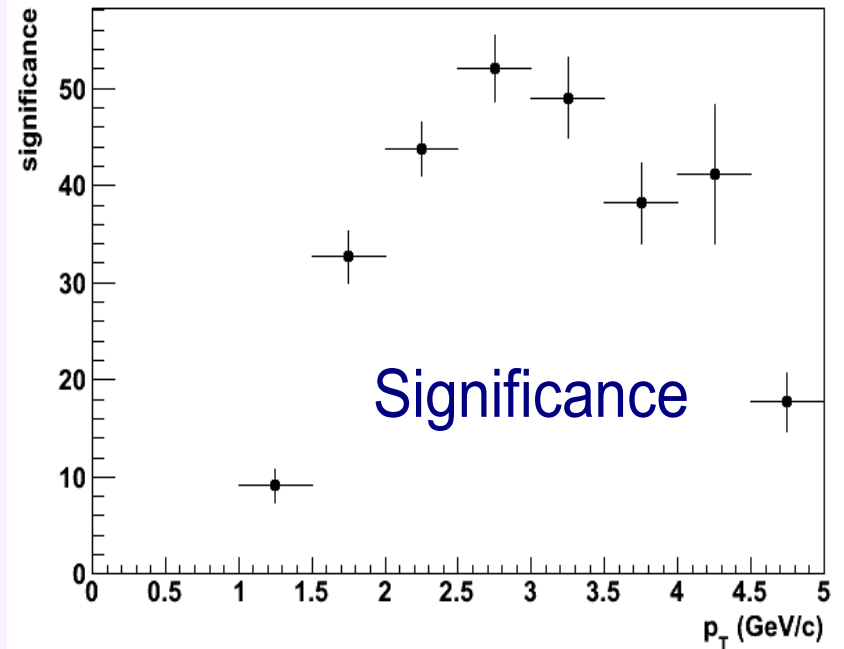
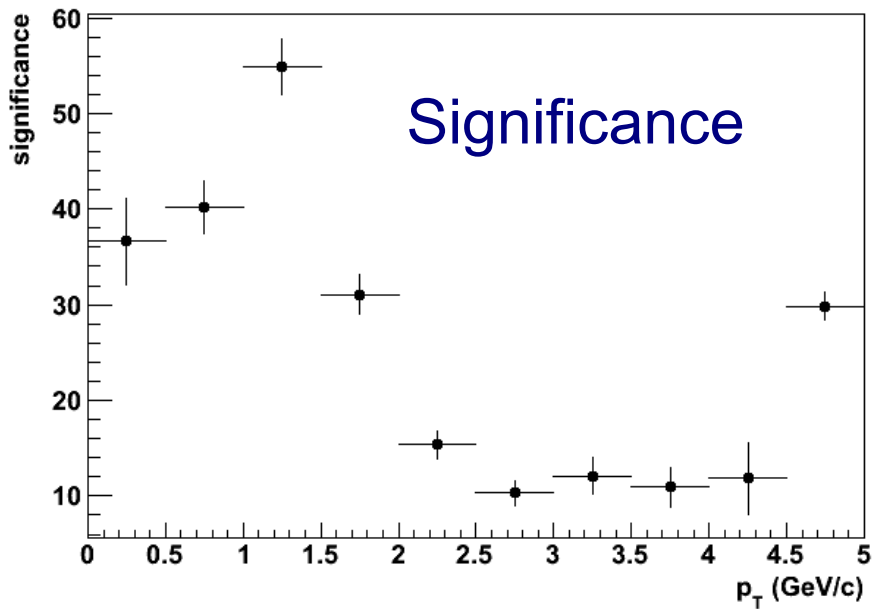

- Numbering (convention)

- ...

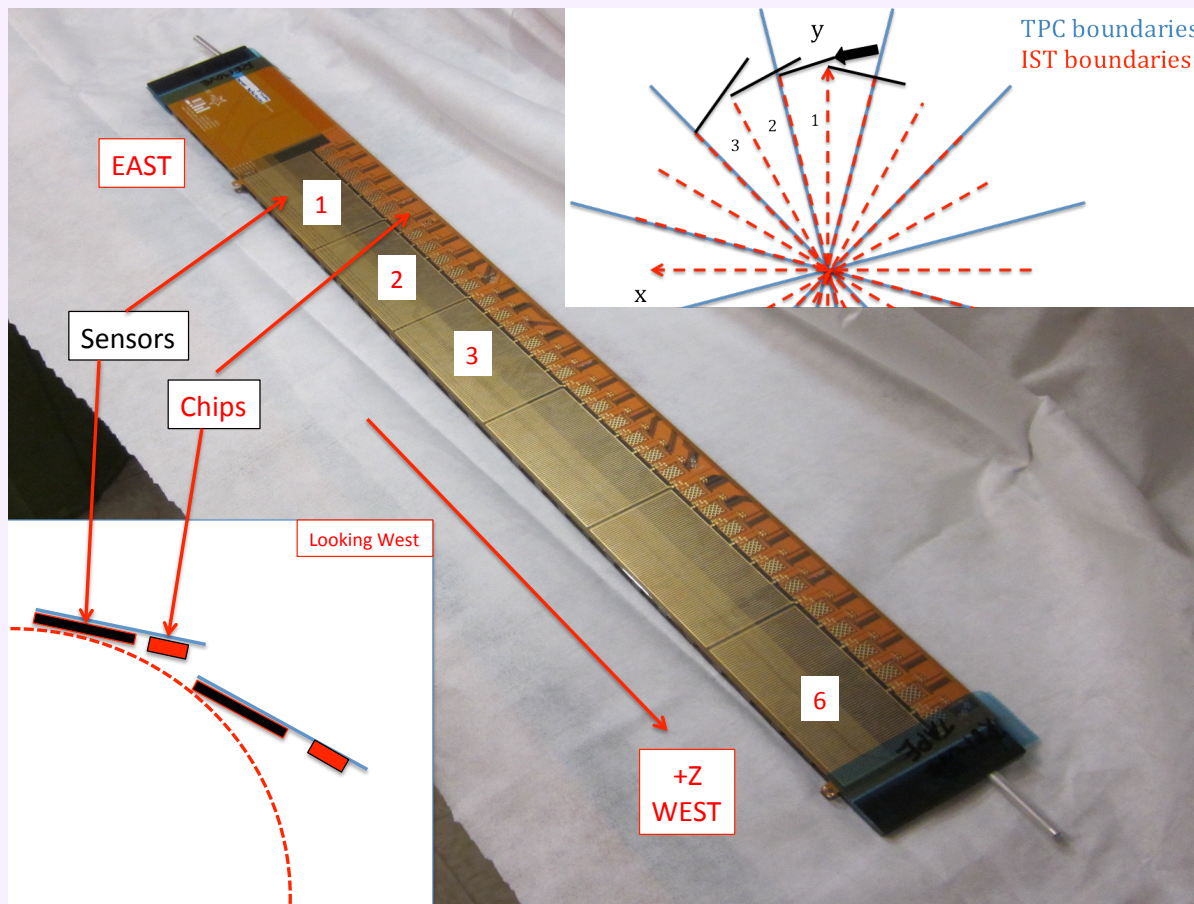

Schedule/Milestones

NOW

Task ID	Task Name	Progress	Duration
1.6	Software	0%	464 days
1.6.1	Online	0%	464 days
1.6.1.1	PXL	0%	251 days
1.6.1.1.1	metrology conversion into hit point software	0%	20 days
1.6.1.1.2	data format unpacker	0%	17 days
1.6.1.1.3	Slow controls integration	0%	40 days
1.6.1.1.4	error condition lookup action implementation	0%	60 days
1.6.1.1.5	plot generation and analysis of status header	0%	60 days
1.6.1.1.6	L3 - PXL online software ready for engineering run	0%	0 days
1.6.1.1.7	Online Software for production PXL	0%	45 days
1.6.1.1.8	L3 - PXL online software ready for production run	0%	0 days
1.6.1.2	IST	0%	284 days
1.6.1.2.1	Data format unpacker	0%	14 days
1.6.1.2.2	Plot generation single ladder	0%	61 days
1.6.1.2.3	Pedestal software	0%	50 days
1.6.1.2.4	Diagnostic software	0%	50 days
1.6.1.2.5	L3-online software ready for ladder tests tests	0%	0 days
1.6.1.2.6	Update software for IST layer	0%	60 days
1.6.1.2.7	L3 - IST Online Software Complete	0%	0 days
1.6.1.3	SSD	0%	195 days
1.6.1.3.1	data format unpacker	0%	25 days
1.6.1.3.2	Create Online Plots	0%	1 mon
1.6.1.3.3	Create, Program and Test Pedestal Algorithm	0%	20 days
1.6.1.3.5	SSD ready to take ladder data	0%	0 days
1.6.1.3.7	update software for complete SSD	0%	30 days
1.6.1.3.8	L3 - SSD Online Software Complete	0%	0 days
1.6.1.4	Calibration and alignment	0%	464 days
1.6.1.4.1	Survey Software	0%	180 days
1.6.1.4.1.2	CMM analysis software development	0%	9 mons
1.6.1.4.1.1	Test and verify	0%	5 mons
1.6.1.4.1.9	Internal Review of CMM survey software progress	0%	0 days
1.6.1.4.5	CMM analysis	0%	318 days
1.6.1.4.5.1	Analysis of PXL	0%	318 days
1.6.1.4.5.1.10	prototype ladder analysis	0%	3 mons
1.6.1.4.5.1.11	Database entry delivered	0%	0 days
1.6.1.4.5.1.12	production ladders	0%	4 mons
1.6.1.4.5.1.13	L3 PXL Database entry delivered	0%	0 days
1.6.1.4.5.2	Analysis of IST	0%	60 days
1.6.1.4.5.2.5	CMM analysis	0%	3 mons
1.6.1.4.5.2.6	L3 IST Database entry delivered	0%	0 days
1.6.1.4.5.3	Analysis of SSD	0%	60 days
1.6.1.4.5.3.1	CMM analysis	0%	3 mons
1.6.1.4.5.3.2	L3 SSD Database entry delivered	0%	0 days
1.6.1.6	Global Alignment	0%	240 days
1.6.1.6.1	Software Development	0%	12 mons
1.6.1.6.2	Testing phase	0%	11 mons
1.6.1.6.3	L3 - Alignment prototype software review	0%	0 days
1.6.1.6.4	L3 - Alignment software for Engineering Run	0%	0 days
1.6.1.8	Self Alignment	0%	240 days
1.6.1.8.9	Software Development	0%	12 mons
1.6.1.8.10	Testing phase	0%	11 mons
1.6.1.8.11	L3 - Alignment prototype software review	0%	0 days
1.6.1.8.12	L3 - Alignment software for Engineering Run	0%	0 days

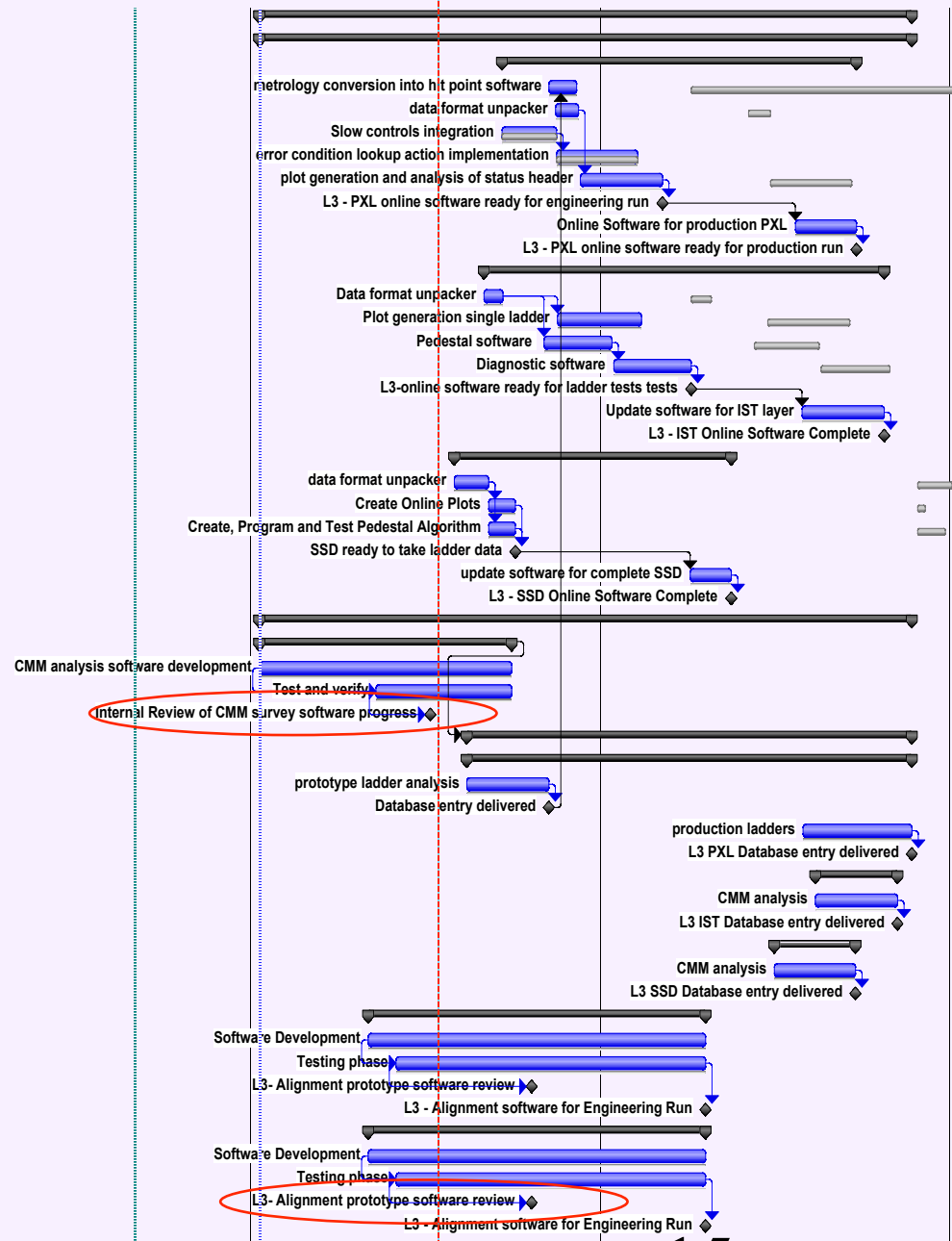

FTEY

Software task		BNL	IPHC	UCLA	KSU	NPI	MIT	LBL	Purdue	USTC
Offline										
Hit Reconst.	IST						X			
	Pixel							X	X	
Tracking		X	X							
Event Vertex		X	X		X	X				
Decay Vertex		X	X		X	X				X
Calibration Db	SSD	X			X			X		
	IST	X					X			
	PXL	X						X	X	
Alignment	SSD	X			X			X		
	IST	X			X		X			
	PXL	X			X			X	X	
Simulation										X
Geometry	SSD	X			X			X		
	IST	X					X			
	PXL	X						X		
Fast/Slow Sim.	SSD				X			X		
	IST				X		X			
	PXL		X					X	X	
Embed./Pileup	IST				X		X	X	X	X
Assoc/Analysis		X			X	X				

UPDATES

2

2

2

1.5

4.7

2

1.1

0.8

0.5

Summary

- ...