

STAR Heavy Flavor Tracker

Spiros Margetis (Kent State Univ.)
for the STAR Collaboration

Outline

- Physics motivation
- Design
 - Heavy Flavor Tracker
 - PiXeL, IST, SSD detectors
- Status and performance
 - Status
 - Efficiency
 - Survey and alignment
 - Hit residual and track DCA
- Summary

Physics Motivation

- Heavy flavor
 - $m_{b,c} \gg T_C, \Lambda_{\text{QCD}}, m_{u,d,s}$
 - Produced early in initial hard scatterings
 - Total number conserved in system evolution at RHIC
- } Good probe to QGP
- However, it's also difficult to study heavy flavor quarks in experiments
 - Limited yield comparing with light flavor particles
 - Short lifetimes, large combinatorial background for direct reconstruction of open heavy flavor hadrons without displaced decay vertex reconstruction
 - Large kinematics smearing for studies with electrons from semi-leptonic decay
 - A precision vertex detector will be an important tool to asses HF physics.

HFT Physics Motivation

- HFT can be used to study heavy flavor production by the measurement of displaced vertices
 - $D^0 \rightarrow K^- \pi^+$
 - BR = 3.83 % $c\tau \sim 120 \mu\text{m}$
 - $\Lambda_c^+ \rightarrow p K^- \pi^+$
 - BR = 5.0 % $c\tau \sim 60 \mu\text{m}$
 - B mesons $\rightarrow J/\psi + X$ or $e + X$
 - $c\tau \sim 500 \mu\text{m}$

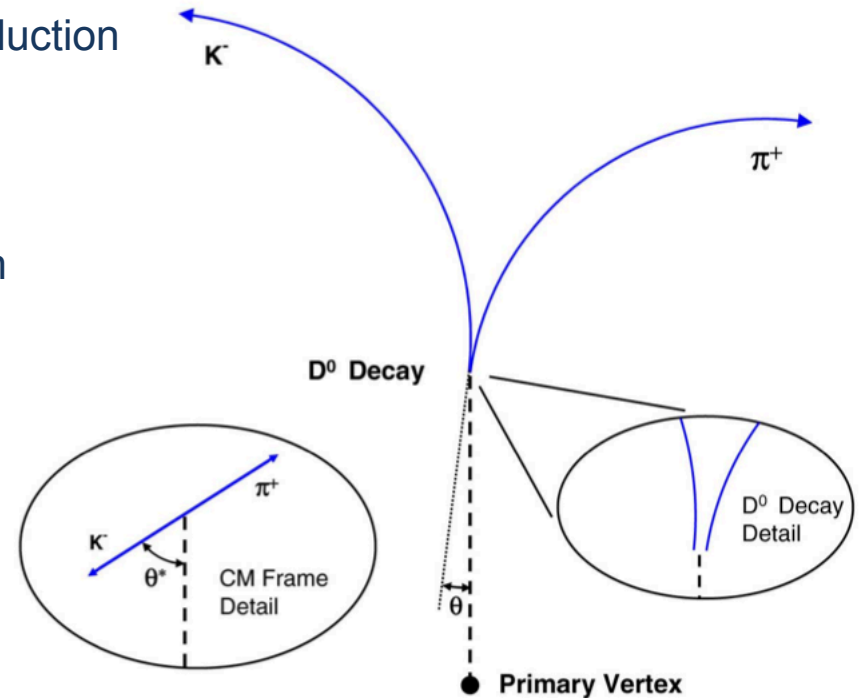

- Total charm yield \Rightarrow base line for charmonium suppression & coalescence
- R_{CP}, R_{AA} of charm and bottom \Rightarrow energy loss in QGP
- Charm (D^0) flow \Rightarrow thermalization?
- $c\bar{c}$ ($D^0\bar{D}^0$) angular correlation \Rightarrow interaction with the medium
- Λ_c^+/D^0 \Rightarrow test coalescence model

Charm Yield, R_{CP} and R_{AA}

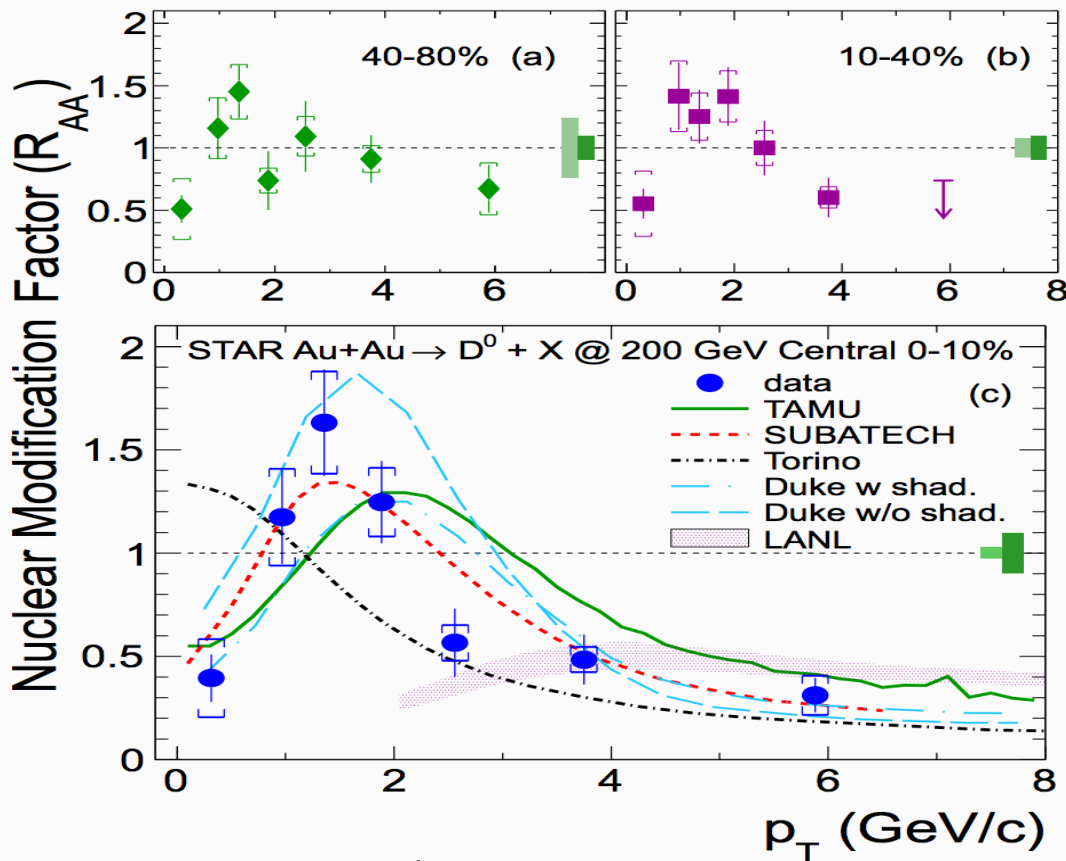

arXiv:1404.6185; subm. to PRL

- Total charm yield \longrightarrow base line for charmonium suppression & coalescence
- R_{CP} , R_{AA} \longrightarrow energy loss mechanism, QCD in dense medium

Charm Yield, R_{CP} and R_{AA}

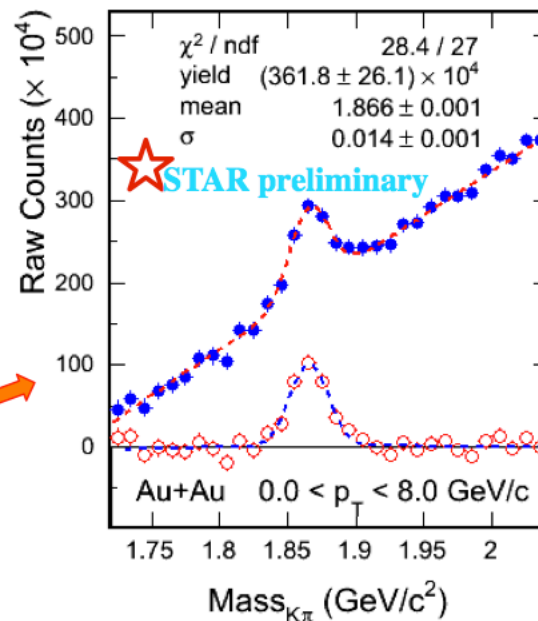
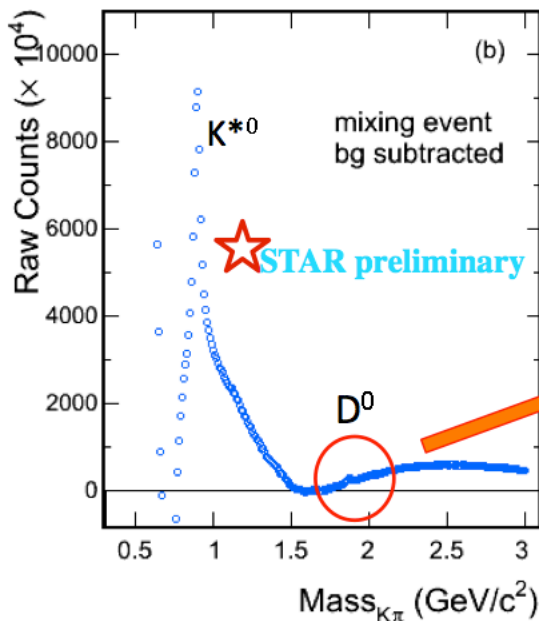
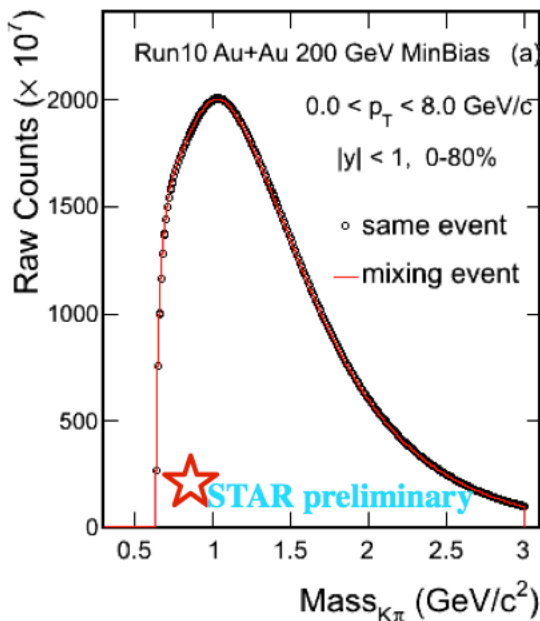

arXiv:1404.6185; subm. to PRL

- Large combinatorial background using primary tracks to reconstruct D^0
- Much better S/B ratio with displaced vertex from HFT

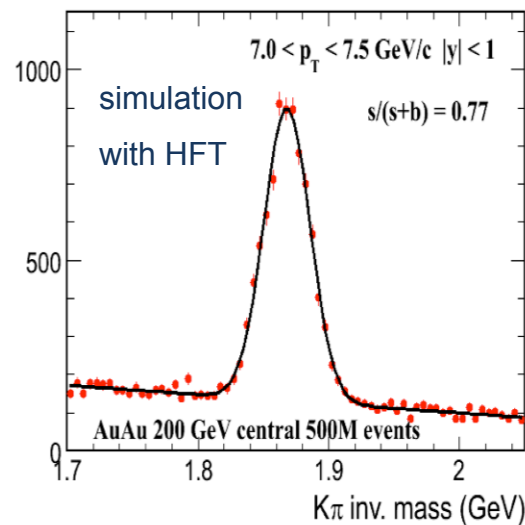
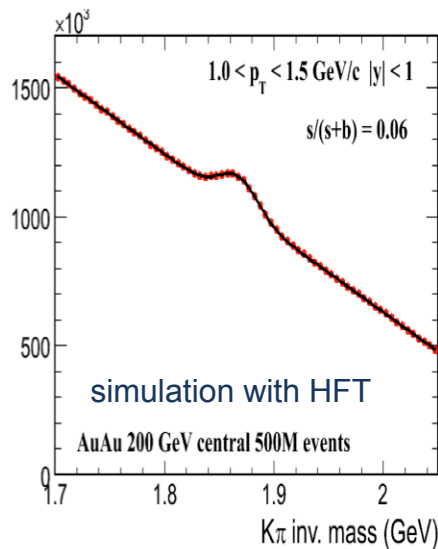

Charm Yield, R_{CP} and R_{AA}

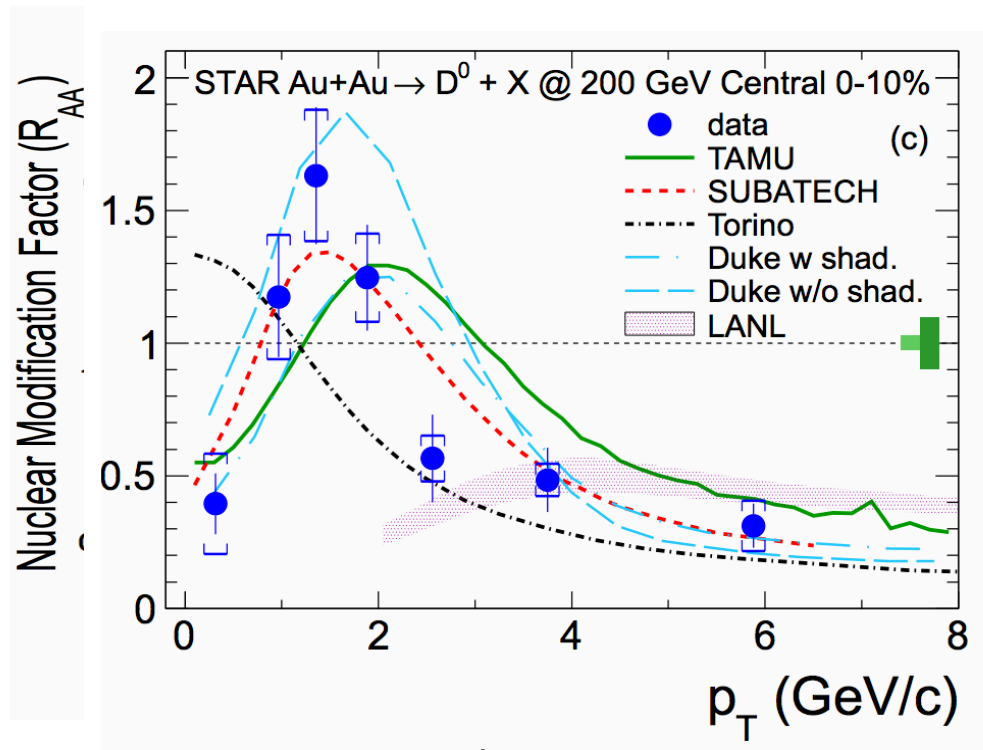

arXiv:1404.6185; subm. to PRL

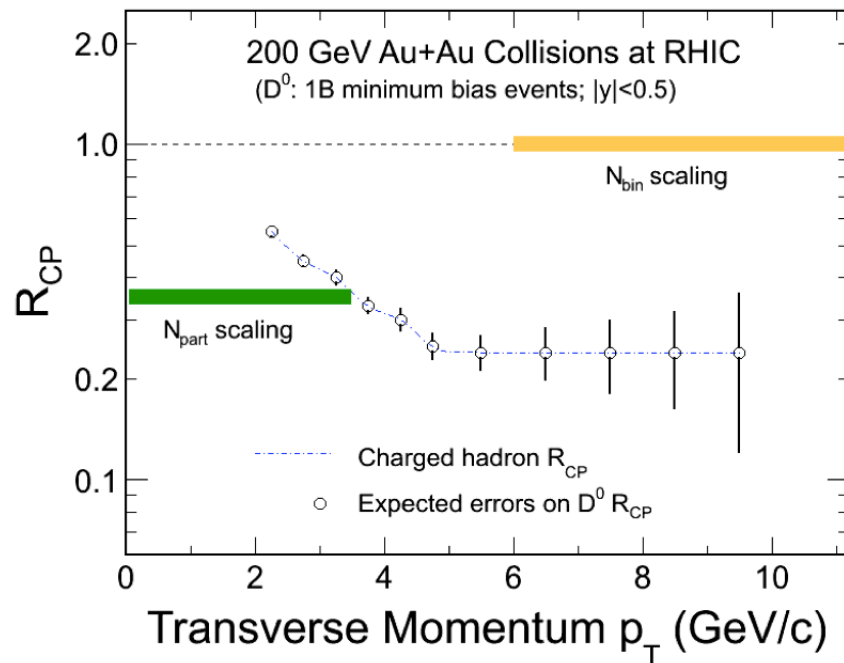

STAR projection with HFT

HFT CDR (STAR Note SN0600)

- Much better precision with HFT than current STAR measurement
- Low radiation length enable reconstruction of D^0 with p_T starting from ~ 0 , enabling charm total cross section measurement.

Charm Yield, R_{CP} and R_{AA}

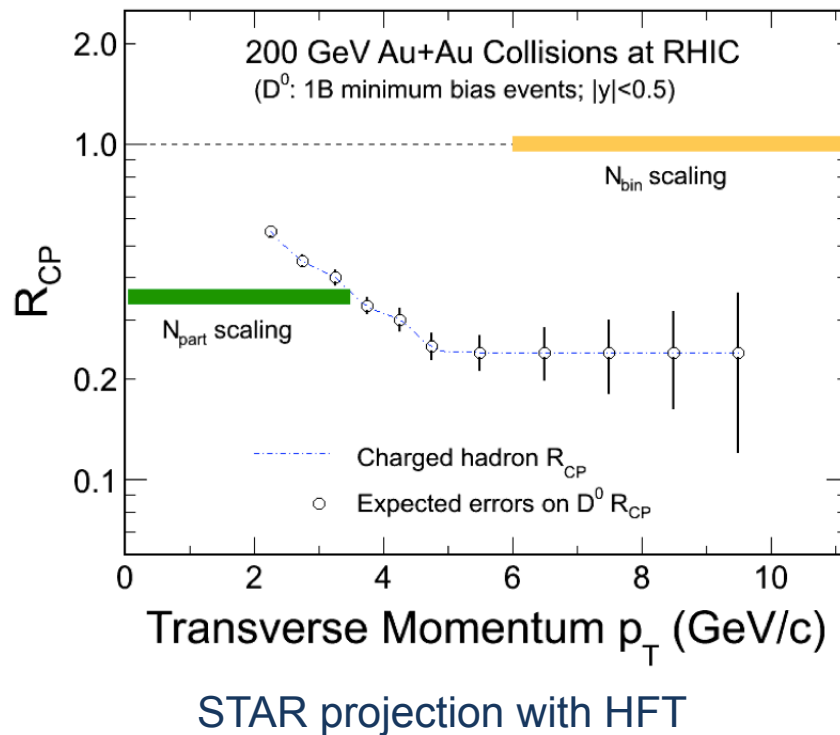
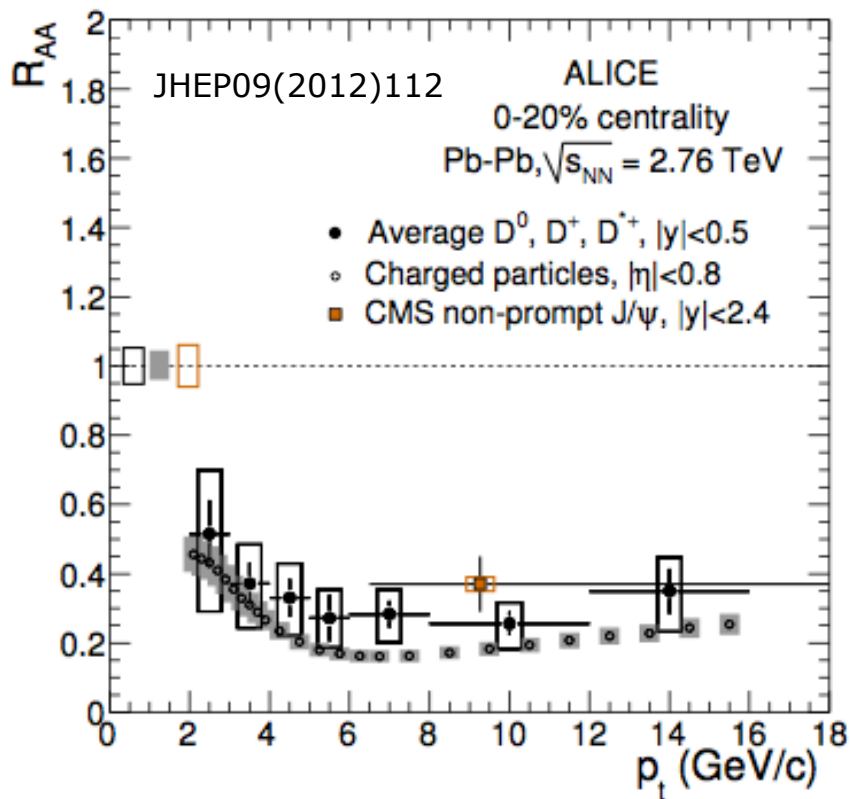

- Probe possible different medium property with different collision energy.

Charm Flow

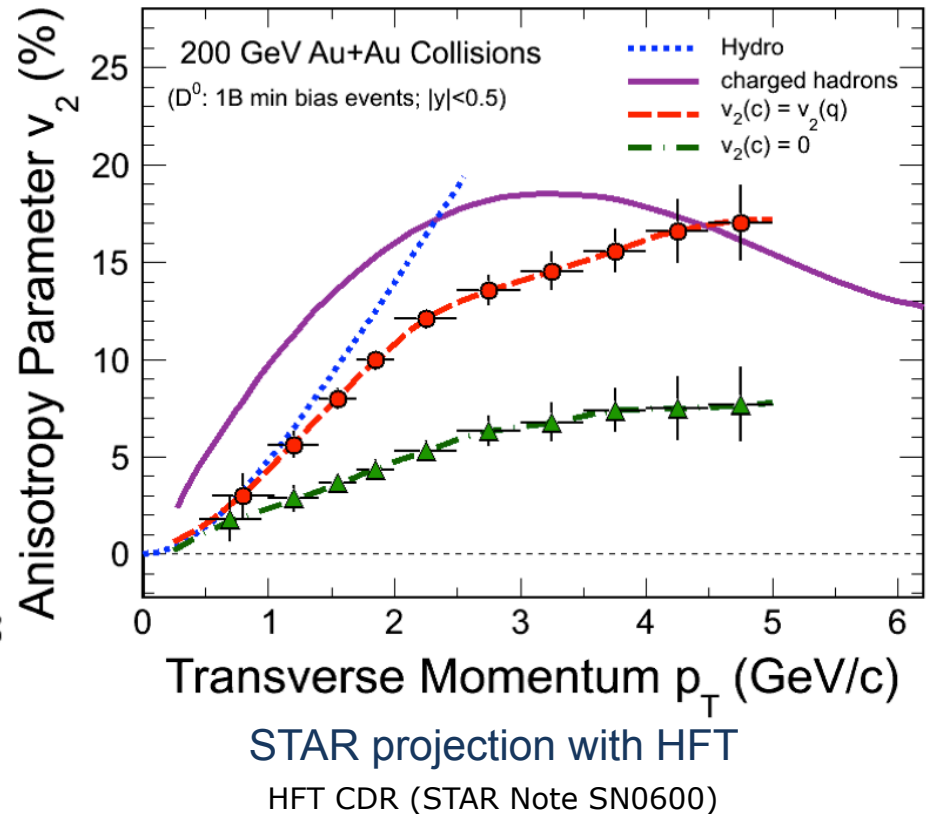
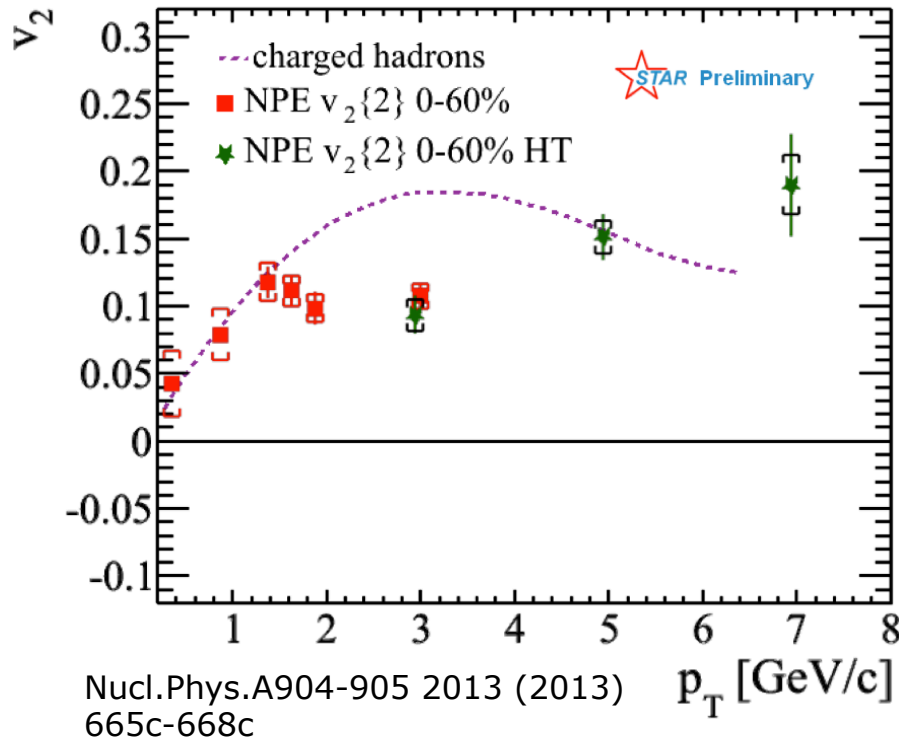

- Charm collectivity  light flavor thermalization?
- $D^0 v_2$ is a more direct measurement of charm flow than non-photon electron v_2 .
- With HFT STAR is able to measure $D^0 v_2$ at low p_T region, which is sensitive to charm flow.

Charm Flow

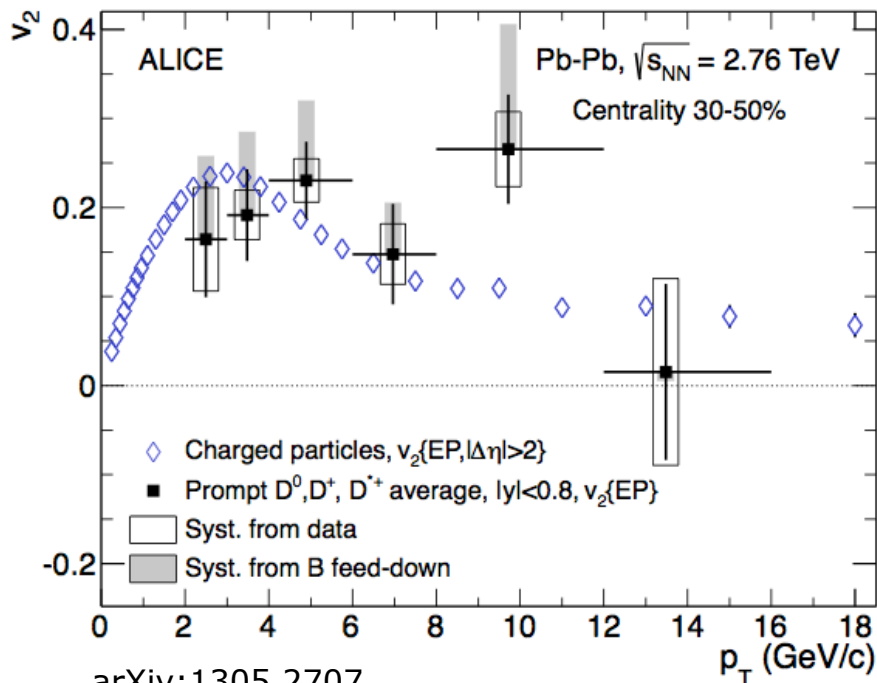

arXiv:1305.2707

Phys. Rev. Lett. 111 (2013) 102301

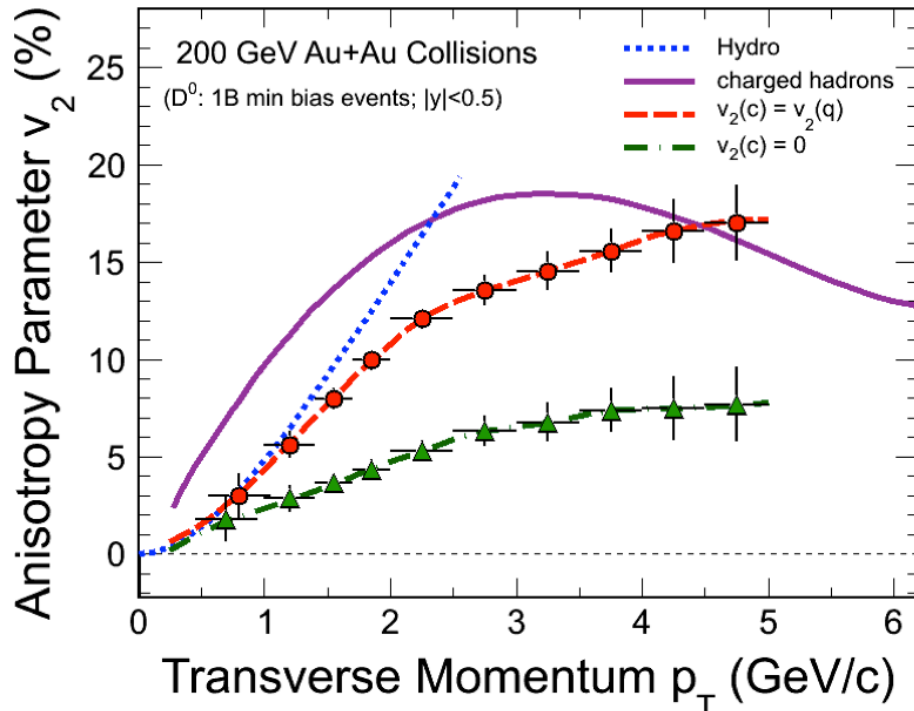

STAR projection with HFT

HFT CDR (STAR Note SN0600)

- Charm collectivity \longrightarrow light flavor thermalization?
- Measurements at both LHC and RHIC will explore the change of media properties with energy.

J/ψ from B meson

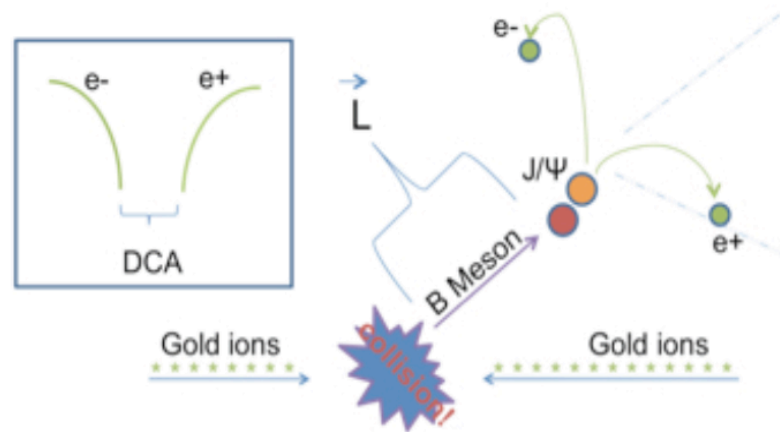
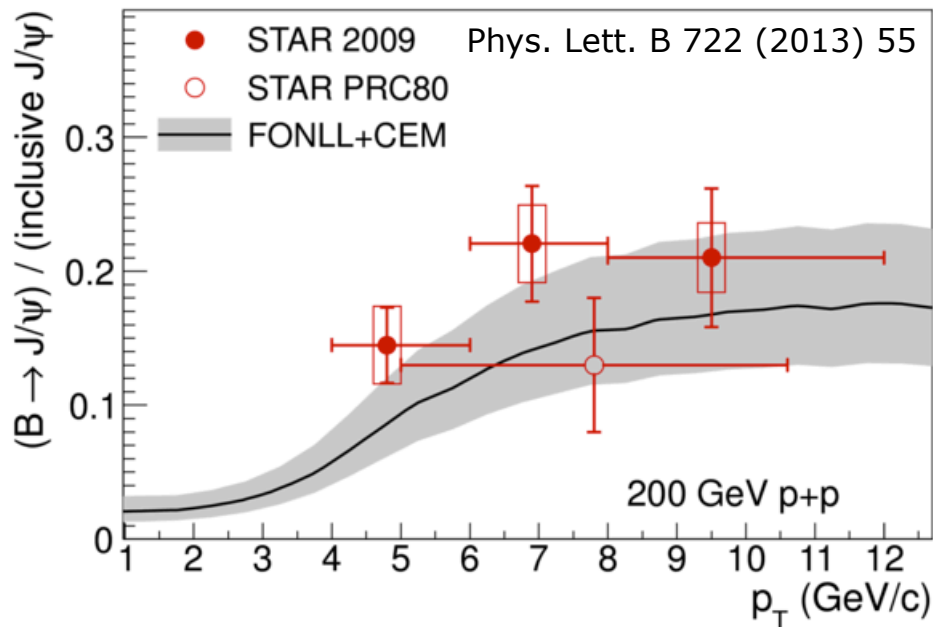

- Measured before through J/ψ-hadron correlation
 - only in p-p collisions
 - large errors
- with HFT can be measured by displaced vertex
- with MTD can also be measured through $\mu^+\mu^-$ channel

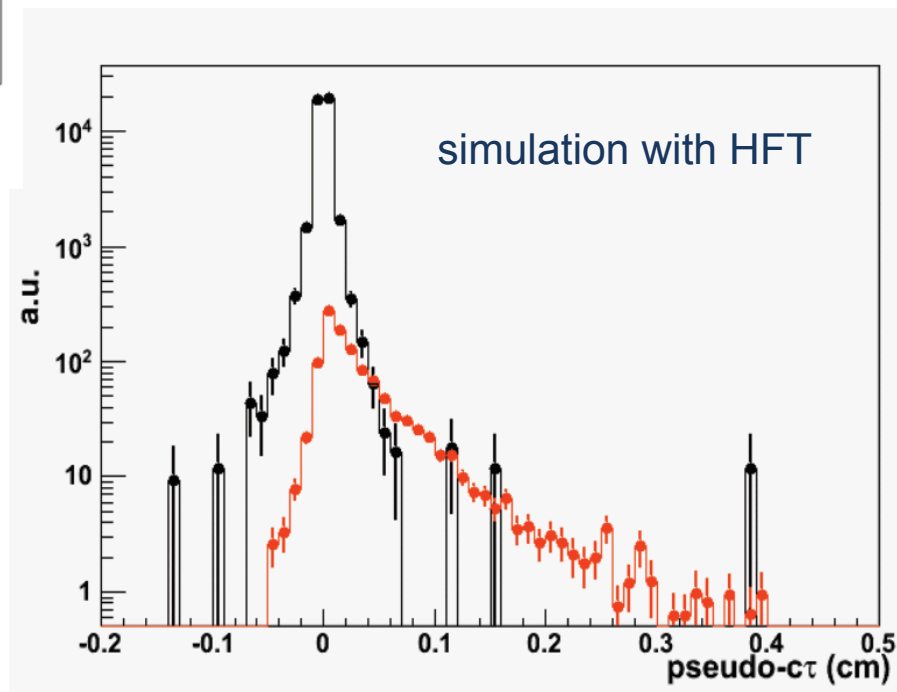

HFT in STAR

**Tracking & dE/dx:
Time Projection Chamber**

**Particle ID:
Time Of Flight detector**

**Electromagnetic
Calorimetry:
Barrel EMC
+Endcap EMC**

**Muon Telescope
Detector (runs 13/14)**

**Heavy Flavor
Tracker (run 14)**

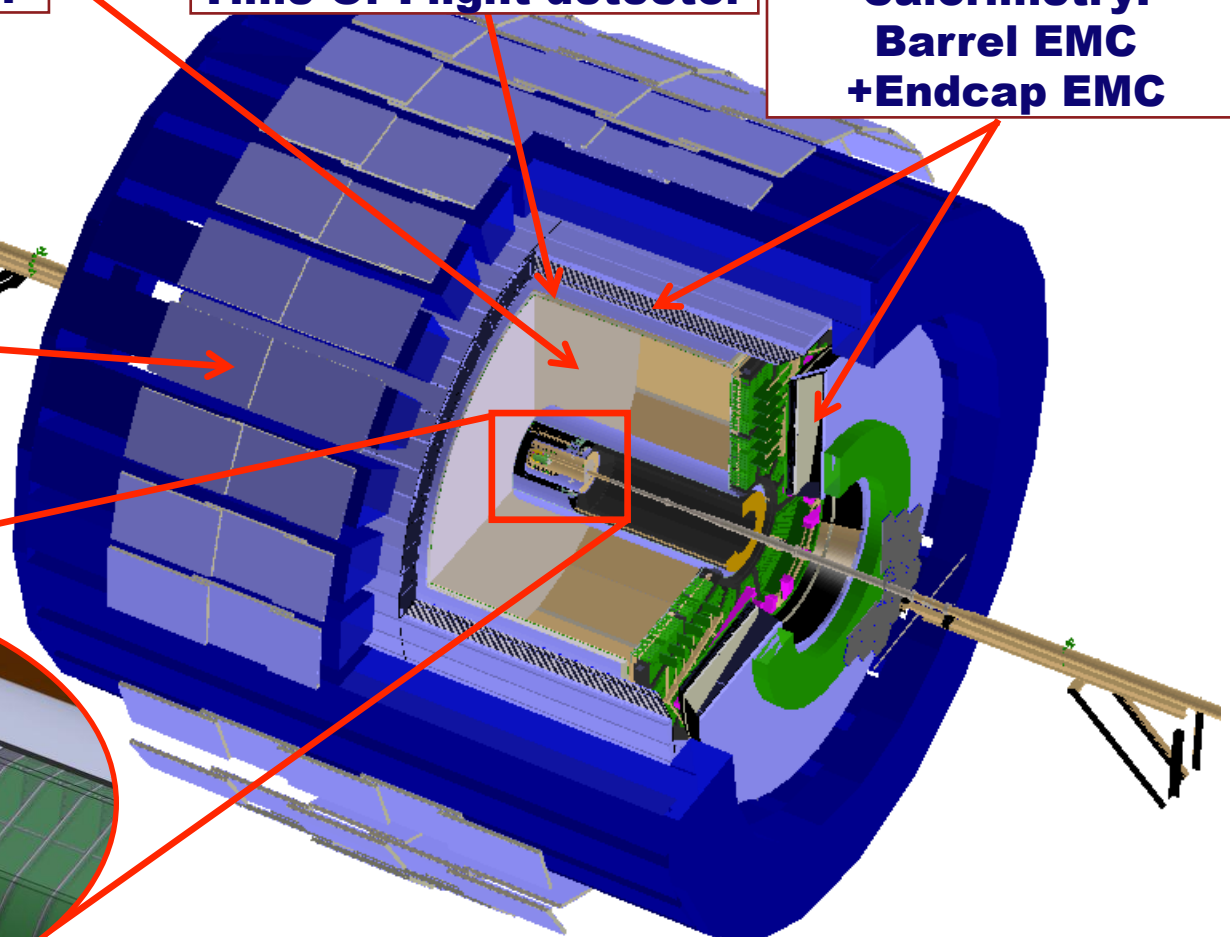
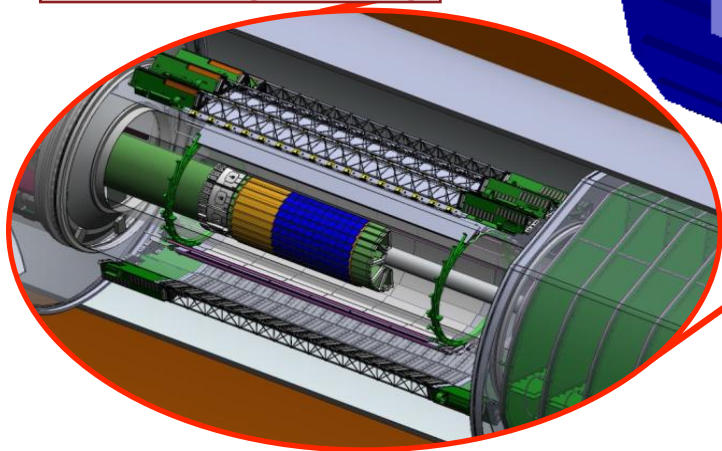

- Full azimuthal particle identification at mid-rapidity

HFT Design

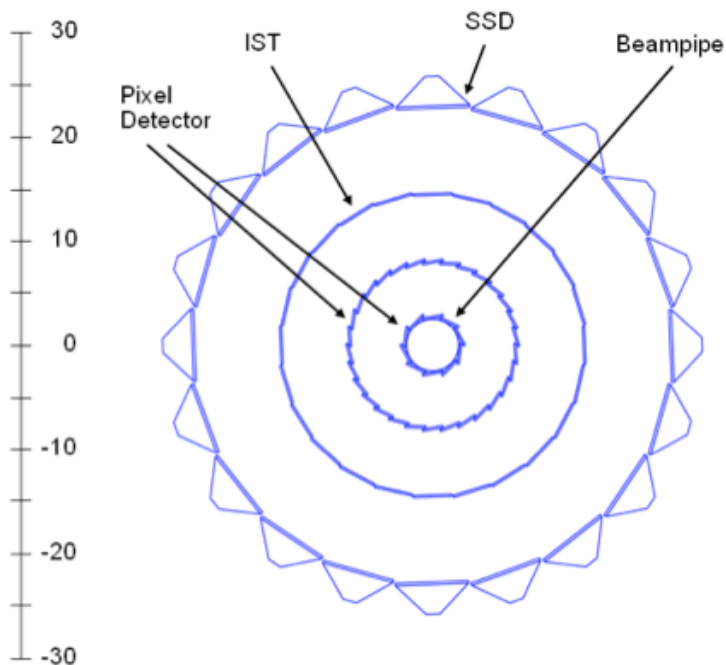

Silicon Strip Detector:

existing detector with new faster electronics

double sided silicon strip modules with 95 μm pitch

$\sigma_{r-\phi}$: 20 μm

σ_z : 740 μm

radius: 22 cm

X/X_0 : 1 %



Intermediate Silicon Tracker:

single-sided double-metal silicon pad

sensors with 600 μm \times 6 mm pitch

$\sigma_{r-\phi}$: 170 μm

σ_z : 1800 μm

radius: 14 cm

$X/X_0 < 1.5$ %

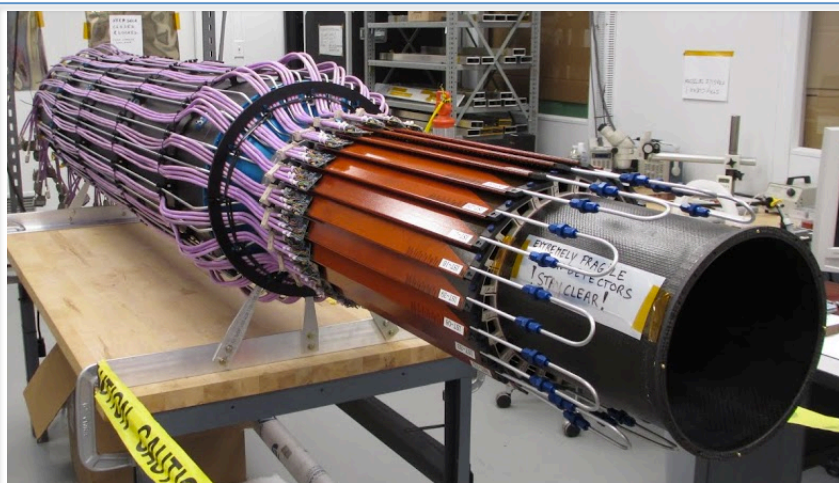

The task of SSD and IST is to guide the track from TPC to the innermost PXL detector with high hit density.

Pixel Detector Design

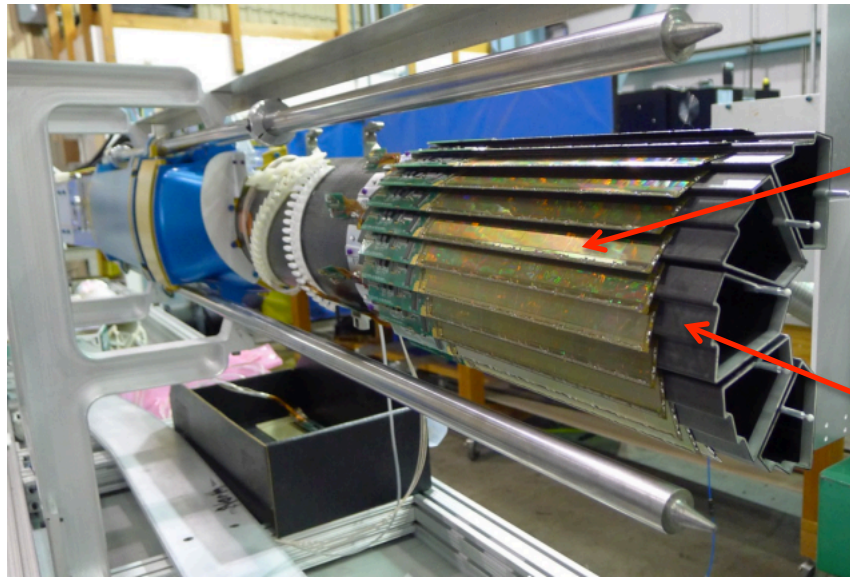

PIXEL detector

- 10 sectors * 4 ladders (1 inner + 3 outer) * 10 Monolithic Active Pixel Sensors (MAPS)
 - 20.7 μm pixel pitch
 - thinned down to 50 μm
 - used in a collider experiment for the first time
- light carbon fiber support
- radius:
 - 2.9 cm (inner)
 - 8.2 cm (outer)
- σ : $\sqrt{\left(\frac{20.7}{\sqrt{12}}\right)^2 + 5^2}$
 - = 7.8 μm vibration
- X/X_0 : 0.4 % / layer
- 360 M pixels in total
- air cooled

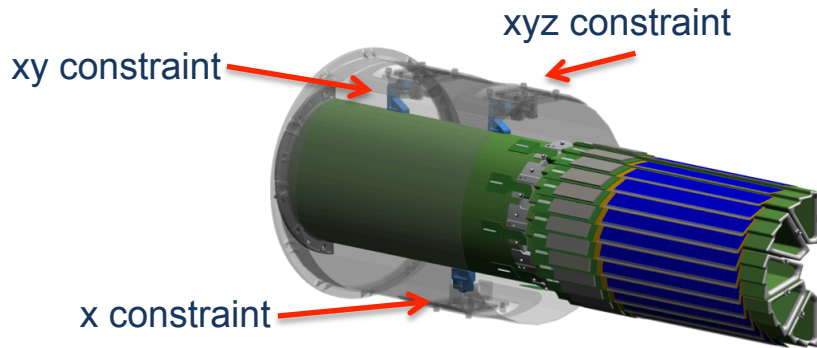

3 kinematic mounts locate the PXL half on the PXL supporting tube.

PXL insertion can be done in ~12 hours, by pushing PXL halves along rails and latching on kinematic mounts.

2 sets of PXL detectors and 40 spare ladders are made, to replace damaged detector units when needed.

Monolithic Active Pixel Sensors

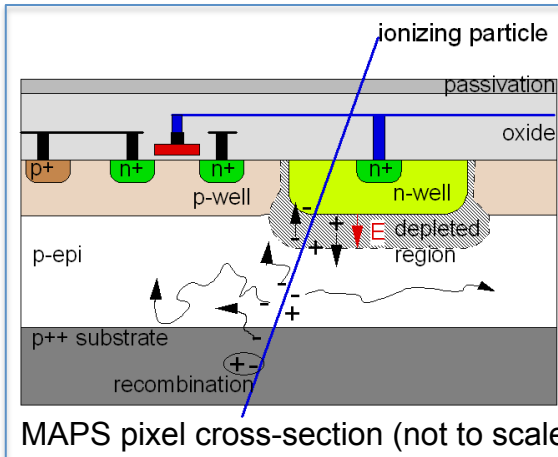

- signal mainly from thermal diffusion in the low-doped epitaxial layer (10~15 μm)
- 100 % fill-factor
- MIP signal < 1000 electrons
- collected in large E-field depleted region

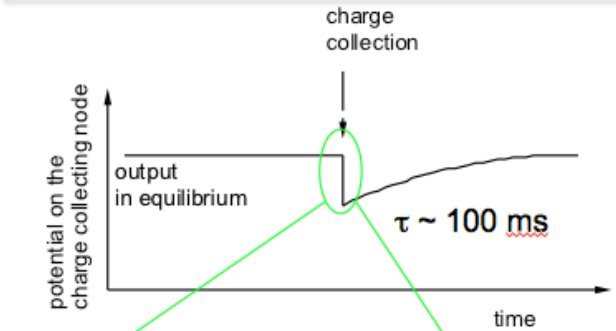

(Sample 1 – Sample 2) > threshold => hit
 (Sample 2 – Sample 3) < threshold => no hit

Correlated Double Sampling

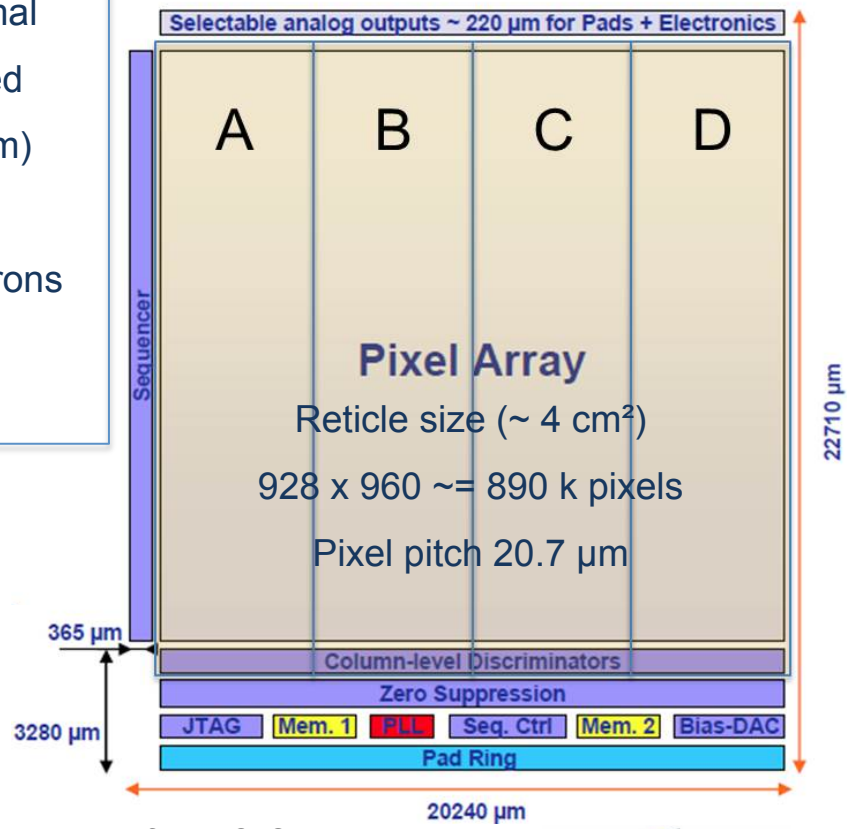
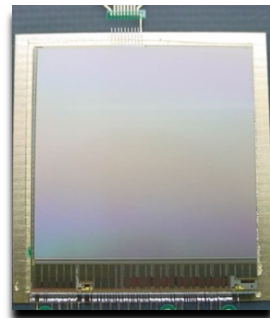

Developed by PICSEL group of IPHC-Strasbourg.
 (Marc Winter et al.)

Thank you!

- standard commercial CMOS technology
- sensor and signal processing are integrated in the same silicon wafer
- discriminator & zero suppression in sensor, readout raw hits directly
- integration time 185.6 μs



HFT Status

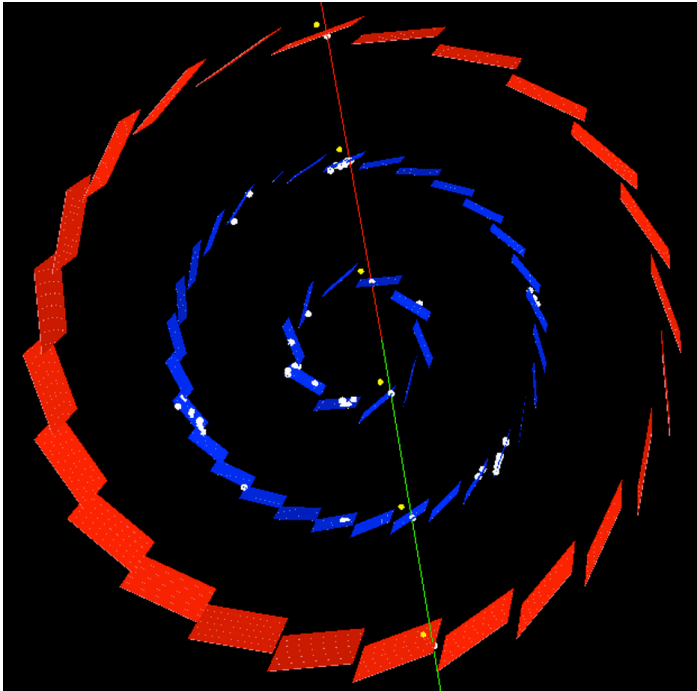

a cosmic event

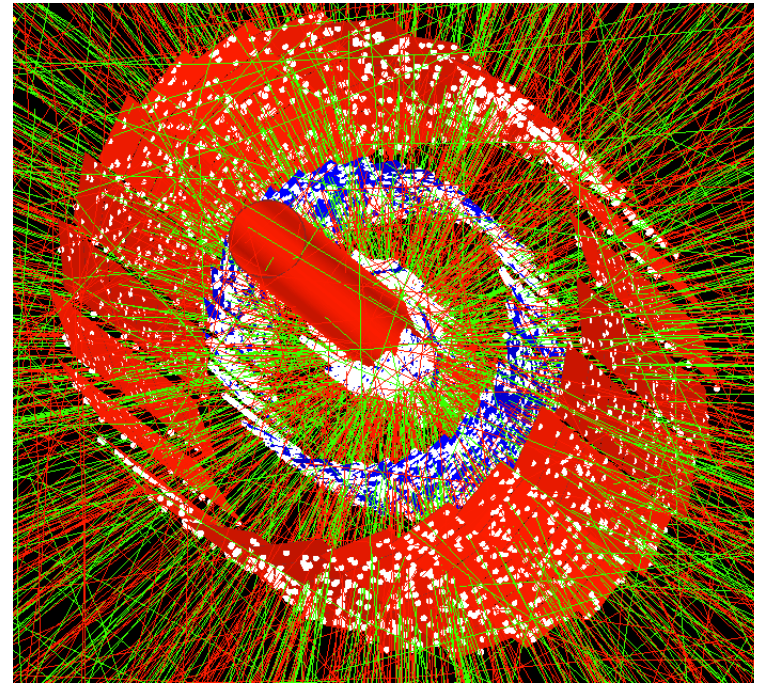

a Au+Au 200 GeV event

- The **full** system has been installed ahead of RHIC 2014 running to take cosmic data for alignment (before Feb. 9 and whenever there is long time with no beam). We also tested 3 PXL sectors in Run-13.
- Some detector performance optimization was done during 14.5 GeV Au+Au run (Feb. 14 ~ Mar. 11)
- 200 GeV Au+Au data taking with PXL and IST since March 15. Collected ~1.2 Billion events so far.
- SSD commissioned later in the run – collected about 150 Million events so far.

Damage and Remediation

Global ϕ vs. global Z, inner

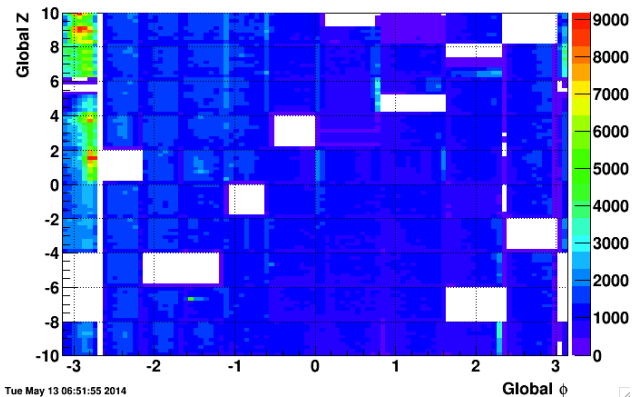

Tue May 13 06:51:55 2014

Z vs. ϕ of hits in PXL inner layer

Global ϕ vs. global Z, outer

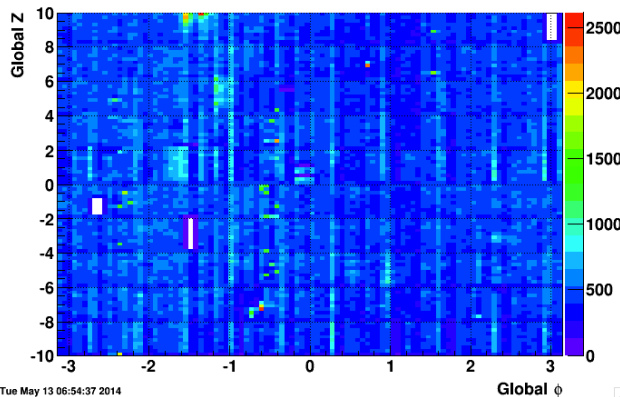

Tue May 13 06:54:37 2014

Z vs. ϕ of hits in PXL outer layer

Global ϕ vs. Global Z

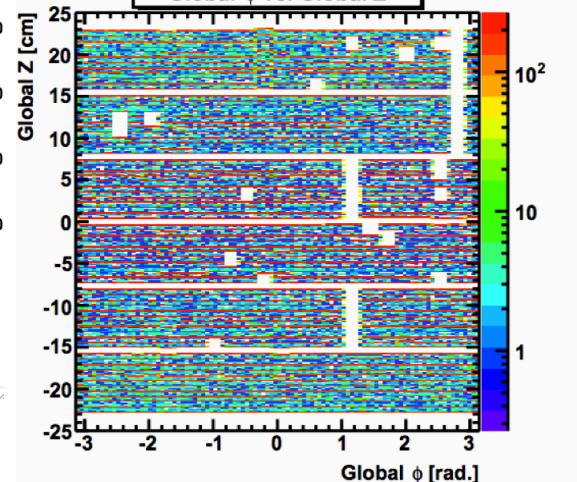

Entries 1267721

Z vs. ϕ of IST hits

layer	inactive units
PXL inner	14 %
PXL outer	1 %
IST	4 %

Most PXL sensor damages appears to be radiation related damage possibly due to latch up in thinned sensors.

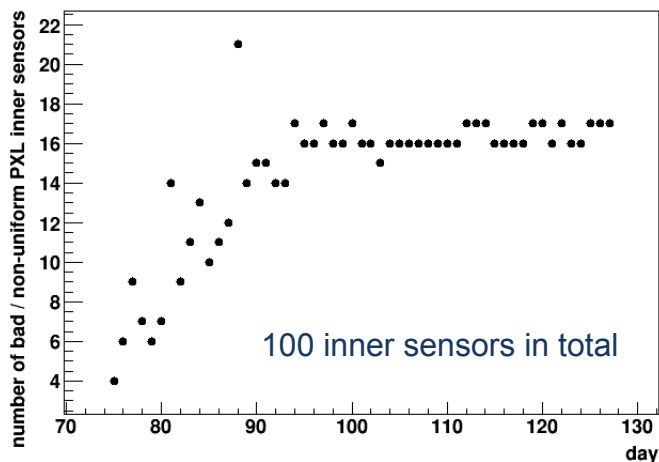

Minimal or no damage for > 1 month: our operational methods were successful at stopping or greatly reducing the rate of damage.

- PXL and IST are only turned on when collision rate < 55 kHz.
- the full PXL detector resets every 15 minutes
- Latch up thresholds changed from 400 mA to 120 mA above the measured operating current for each ladder

Efficiency

Low statistics of near horizontal cosmic

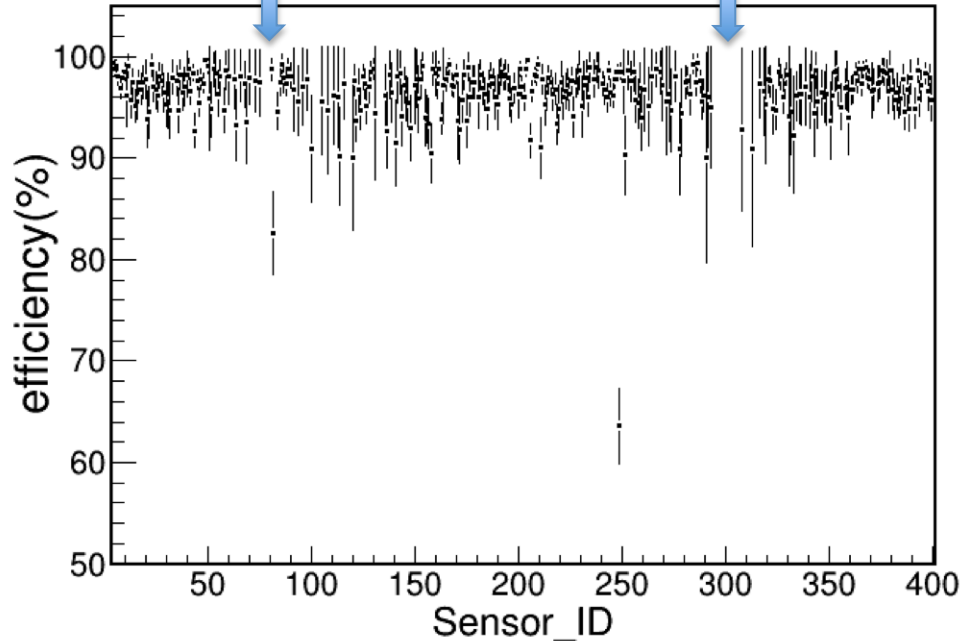

PXL sensor efficiency measured with cosmic ray:
hits / projection

- Before the detector response optimization and running with the beam
- Average = 97.2 %
- Tuning for including HFT in tracking is going on...

operational threshold / noise = 5

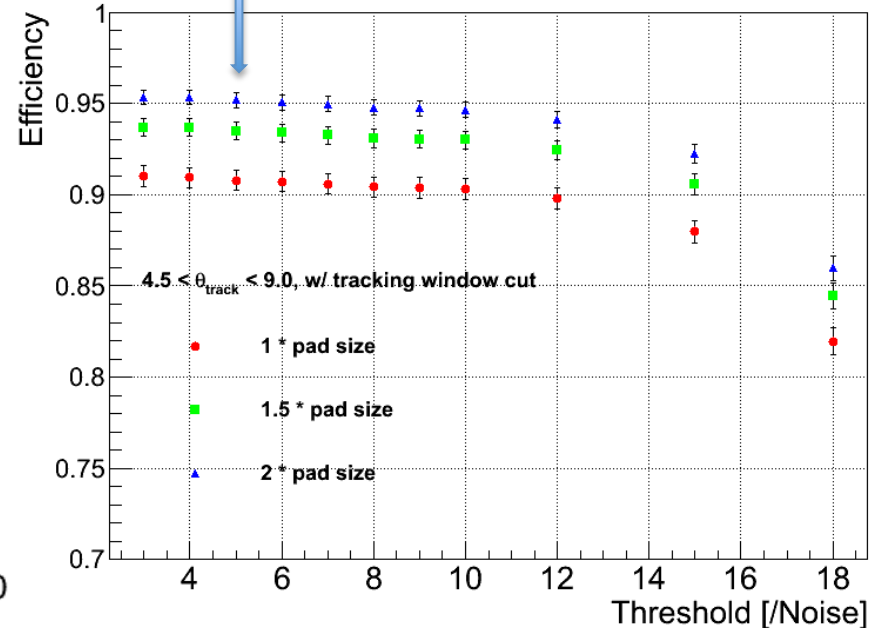

IST efficiency measured with cosmic ray:
hits / projection

~ 95 % at operational threshold / noise

Survey and Alignment

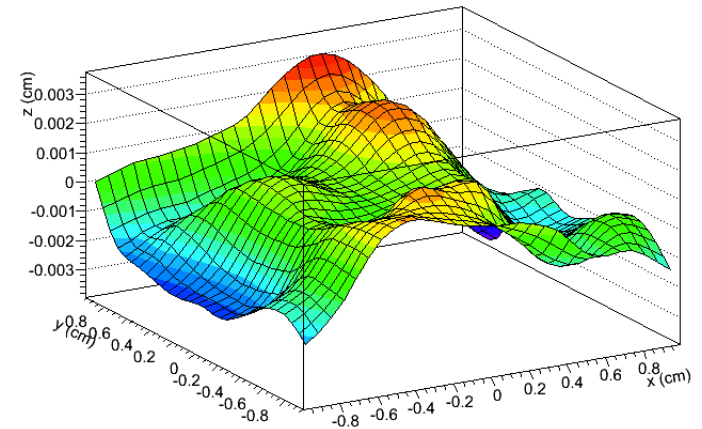
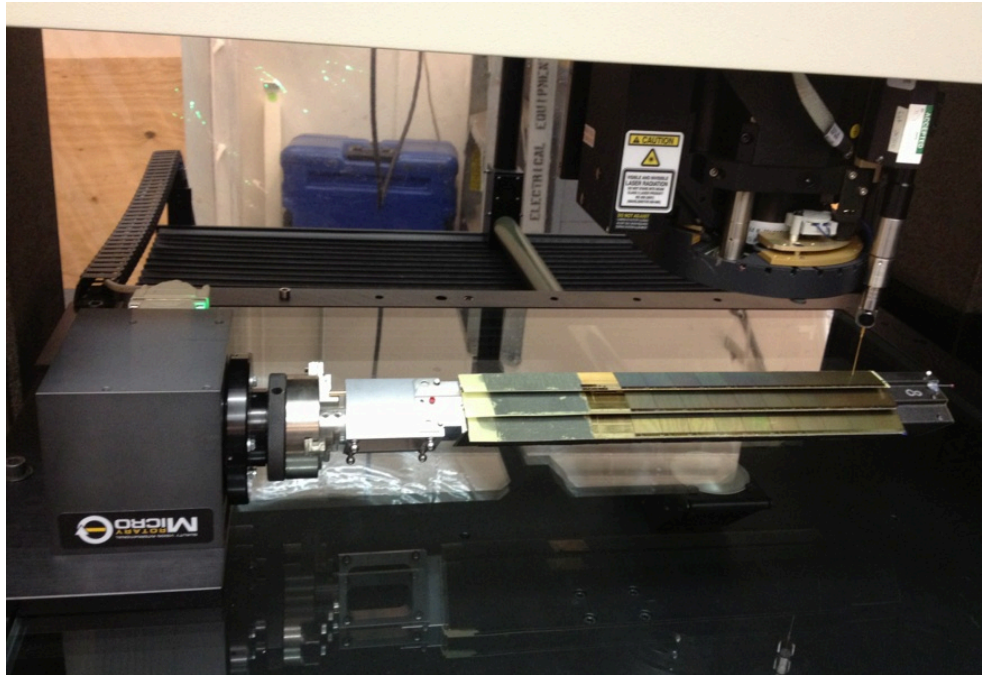

PXL sensor surface profile from survey
 $\pm 30 \mu\text{m} >$ PXL hit error

Coordinate Measurement Machine is used to survey HFT detector parts.

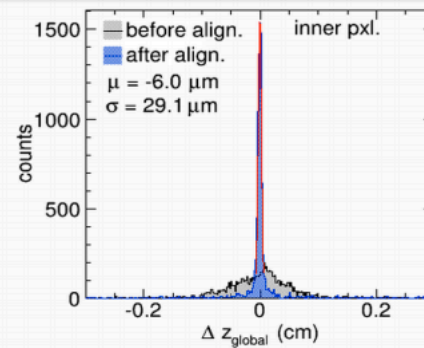
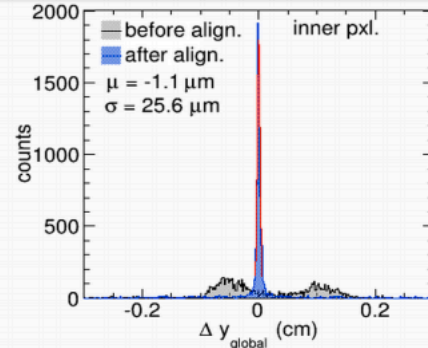
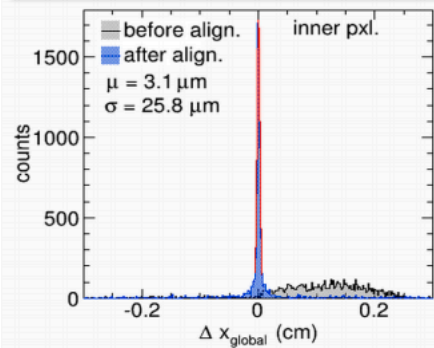

Cosmic ray is used to align different HFT detector parts.

PXL hit residual distribution before and after PXL half to half alignment

Hit Residual and Track DCA

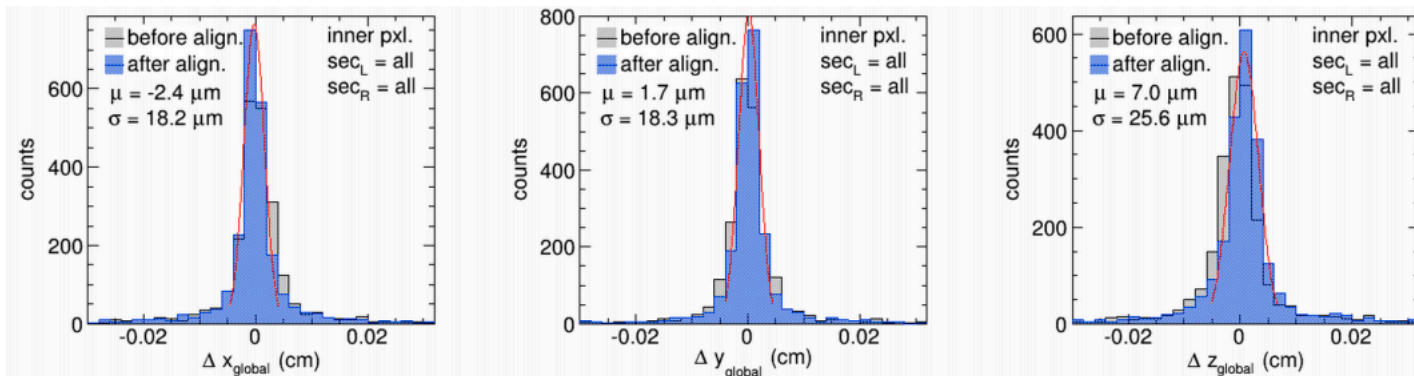

PXL hit residual to cosmic track projection after PXL sector alignment: $\sigma < 25 \mu\text{m}$, match the design goal

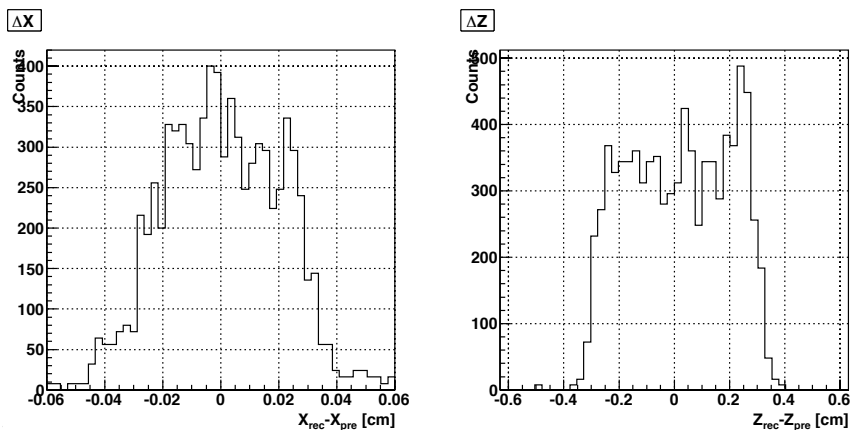

IST hit residuals to cosmic track projection:

$$\sigma_x = 200 \mu\text{m}, \sigma_z = 1800 \mu\text{m}$$

match IST pad size

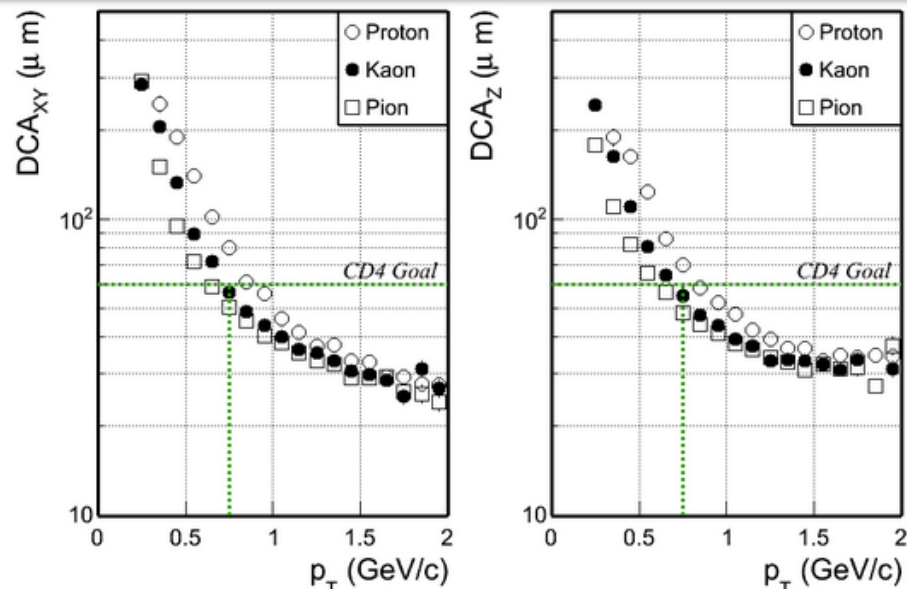

DCA resolution for tracks with TPC + 1 IST hit + 2 PXL hits

~ 30 μm at high p_T

Below project goal: 60 μm for kaon with $p_T = 750 \text{ MeV}/c$

Summary

- STAR Heavy Flavor Tracker will enable or enhance many open heavy flavor measurements, by reconstructing open heavy flavor hadrons with displaced decay vertices.
- State-of-art MAPS technology is used for the first time in a collider experiment in the PXL detector.
- All 3 sub-detectors (PXL, IST, SSD) are finished with construction and inserted into STAR before RHIC year 2014 running.
- With survey and preliminary alignment, we already achieved ~ 30 microns pointing resolution for high p_T tracks reconstructed with HFT hits.
- Data taking with PXL and IST reached our goal for this year. p+p 200 GeV and more Au+Au data will come in runs 15 & 16.
- New physics results with HFT will greatly enhance our understanding of QGP created at RHIC.

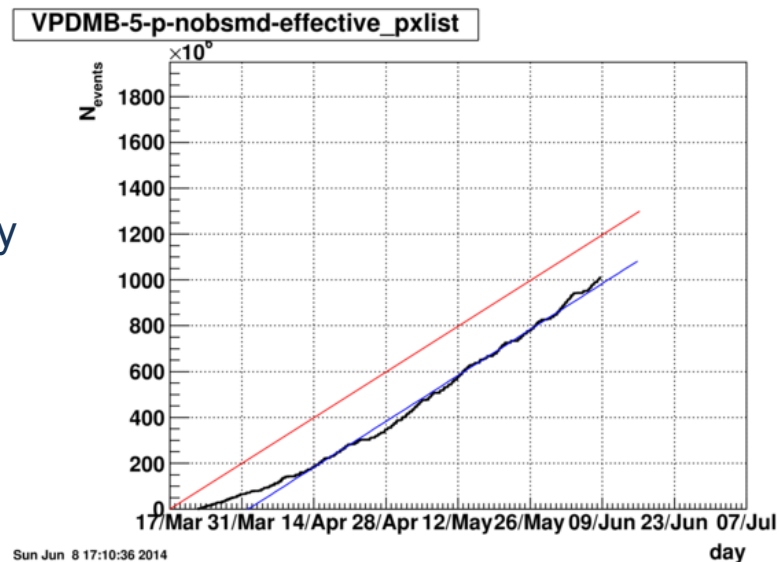

Back Up

STAR Detector Overview

**Tracking & dE/dx:
Time Projection Chamber**

**Particle ID:
Time Of Flight detector**

**Electromagnetic
Calorimetry:
Barrel EMC
+Endcap EMC
+Forward Meson
Spectrometer
($-1 \leq \eta \leq 4$)**

**Muon Telescope
Detector (runs 13/14)**

**Heavy Flavor
Tracker (run 14)**

**Forward GEM
Tracker (runs 12/13)**

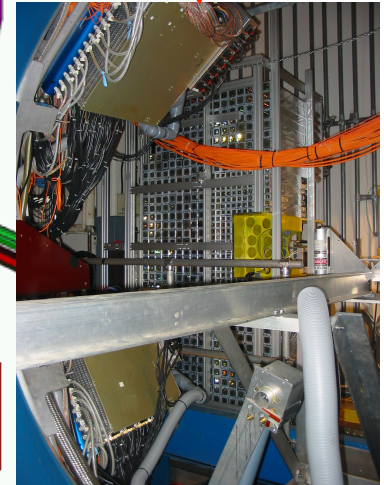
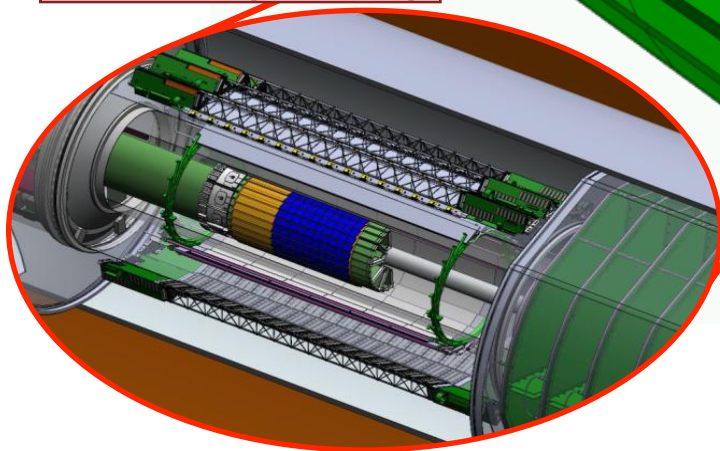

- Full azimuthal particle identification at middle rapidity

HFT Design

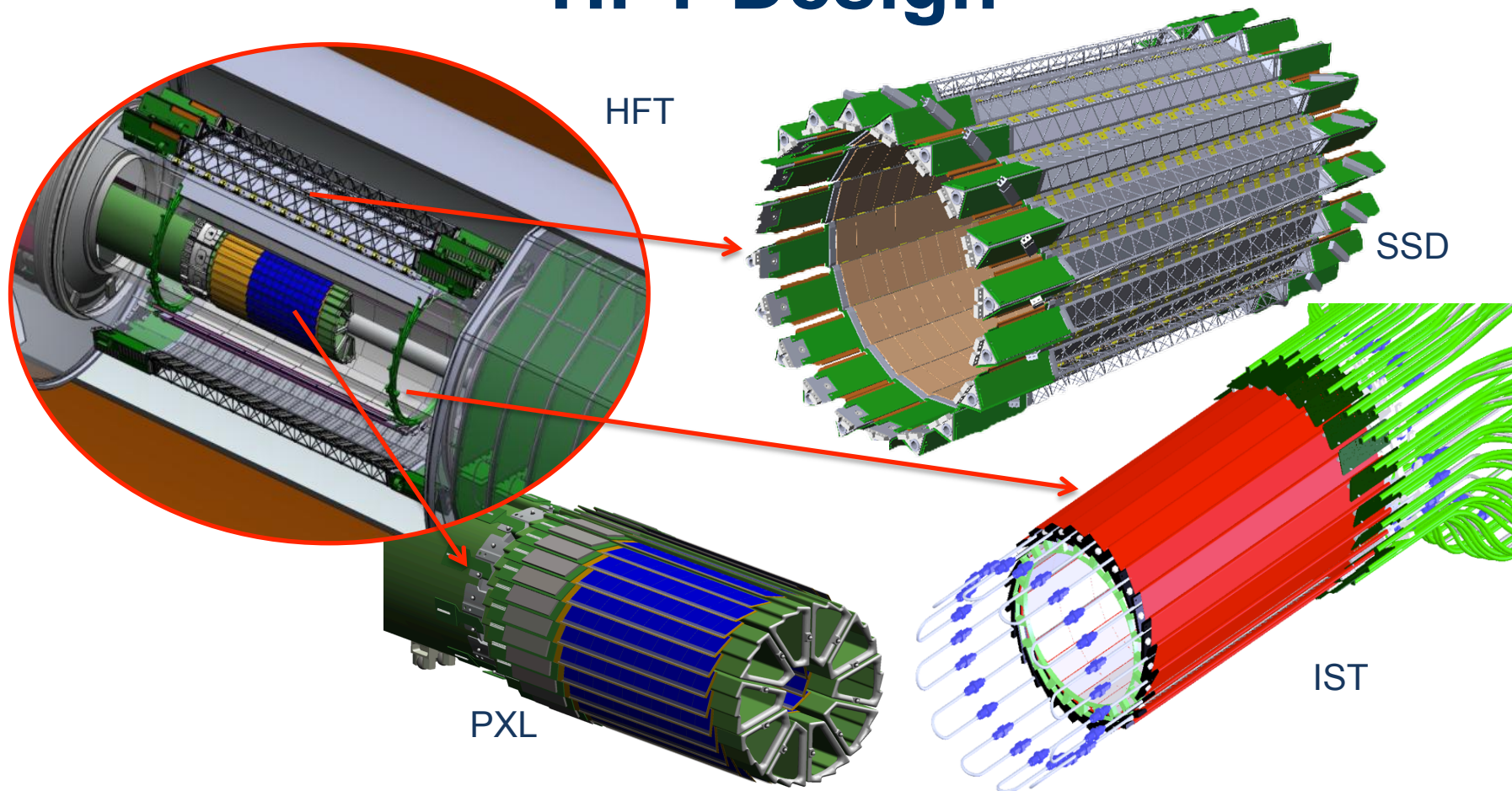

Sub detector	r (cm)	Sensitive units	$\sigma_{R-\phi}$ (μm)	σ_z (μm)	X/X_0 (%)
Silicon Strip Detector	22	2 side strips with 95 μm pitch	20	740	1
Intermediate Silicon Tracker	14	500 μm x 1cm strips	170	1800	<1.5
PIXEL	2.5/8	20 μm pixel pitch	12	12	0.4/layer

HFT Status

- Engineering run for PXL prototype (3 out of 10 sectors) finished
 - installed on May 8, 2013
 - within 12 hours
 - first PXL data in daq file on May 10
 - 78 M events taken with PXL
- full system to be installed in 2014

PXL prototype insertion

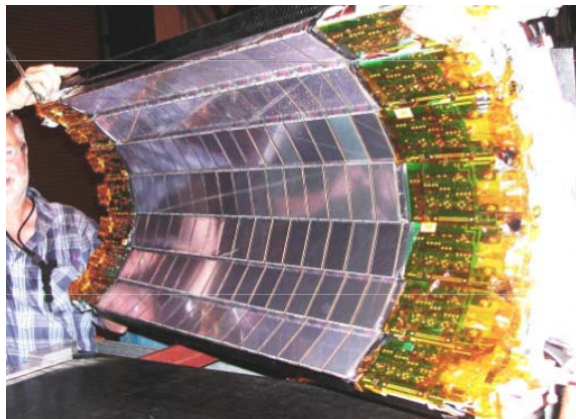
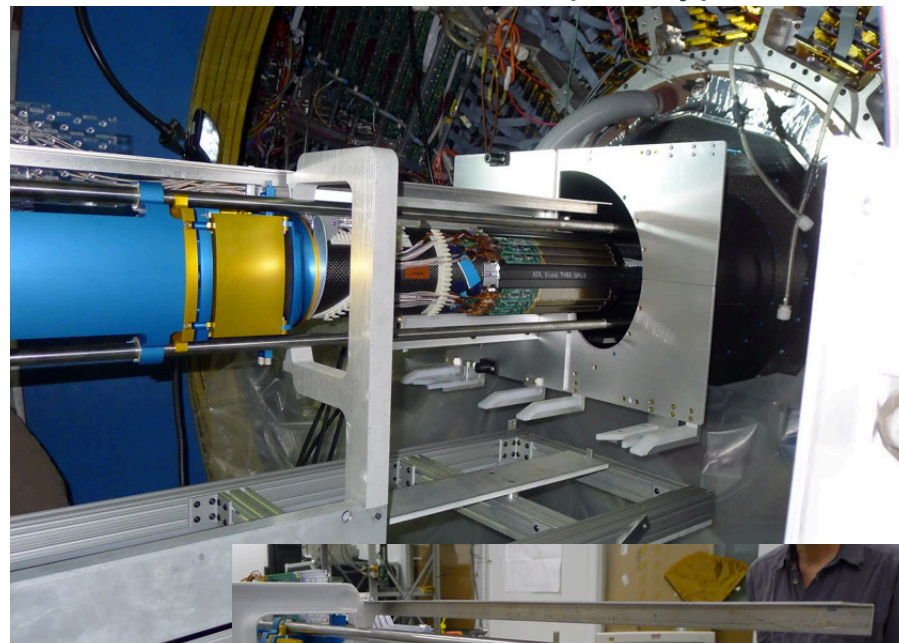

SSD part

IST ladder



PXL prototype half

PXL Performance

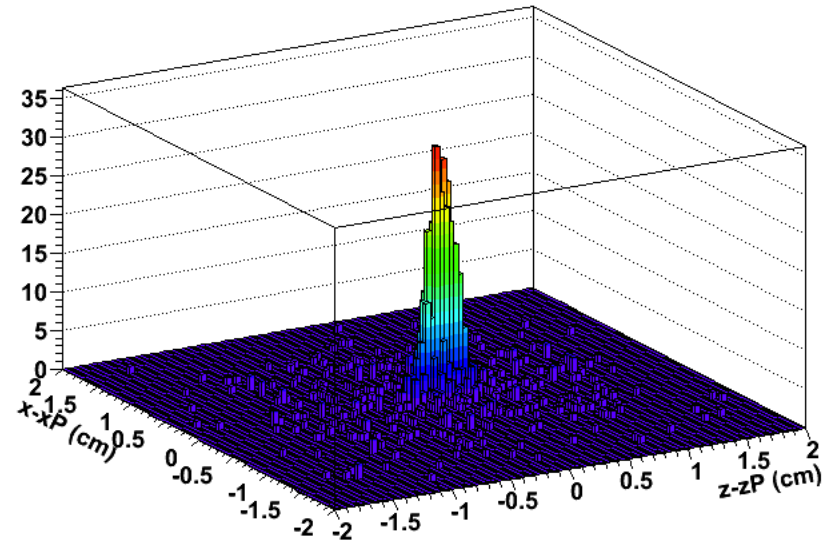
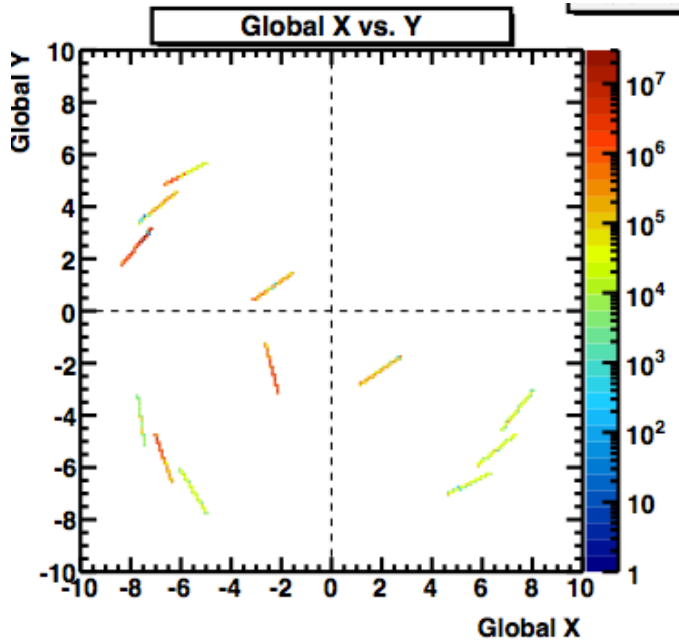

- 2D correlation between measured pxl hit and TPC track projection on a sensor

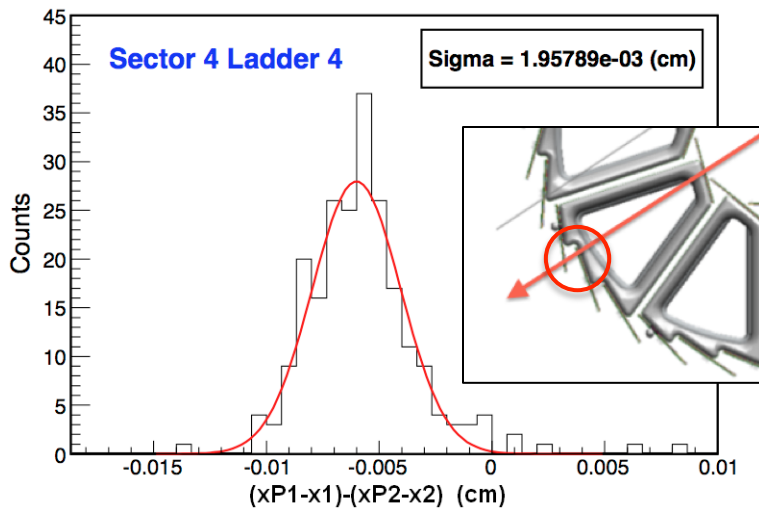

- Double difference of hit and track projection positions between 2 overlapping sensors
- Single sensor resolution = $20 / \sqrt{2} = 14$ microns
~ 12 microns resolution of designed goal

RHIC Run Plan

Run	Energy	Time	System	Goal
14 ⁽¹⁾	$\sqrt{s_{NN}}=200\text{GeV}$	14-week	Au+Au	HFT & MTD heavy flavor measurements, $\mathcal{L}=10\text{ nb}^{-1}$, 1000M M.B.
	$\sqrt{s_{NN}}=15\text{GeV}$	3-week	Au+Au	1) Collect 150M M.B. events for CP search 2) Fixed-target data taking ⁽³⁾
15 ⁽²⁾	$\sqrt{s_{NN}}=200\text{GeV}$	5-week	p+Au	Study saturation physics, pA-ridge and heavy ion reference, $\mathcal{L}=300\text{ nb}^{-1}$
	$\sqrt{s}=200\text{GeV}$	12-week	1) p+p	1) Heavy ion reference data $\mathcal{L}=90\text{ pb}^{-1}$, 500M M.B.
			2) transverse 6 weeks	2) Study transversity, Siverts effects $\mathcal{L}=40\text{ pb}^{-1}$, 60% pol.
			3) longitudinal 6 weeks	3) Study $\Delta g(x)$ $\mathcal{L}=50\text{ pb}^{-1}$, 60% pol.

- STAR Beam User Request, endorsed by RHIC PAC.
- Focus on 200 GeV AA, pA, and pp collisions for heavy ion programs with new upgrades.

Signal, Pedestal and Noise Scan

IST hit ADC spectrum w/ track angle correction

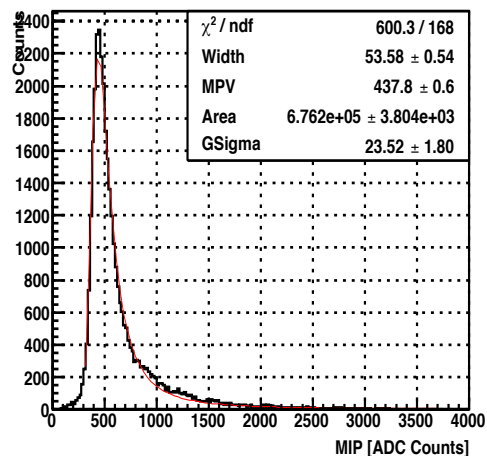

IST signal with MIP
MVP ~ 440 ADCs

- signal to noise ratio ~ 23

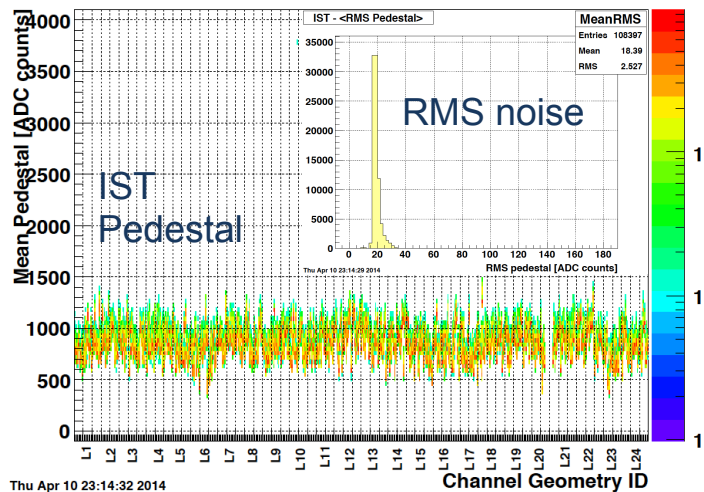

IST has stable pedestal and RMS level
over all channels

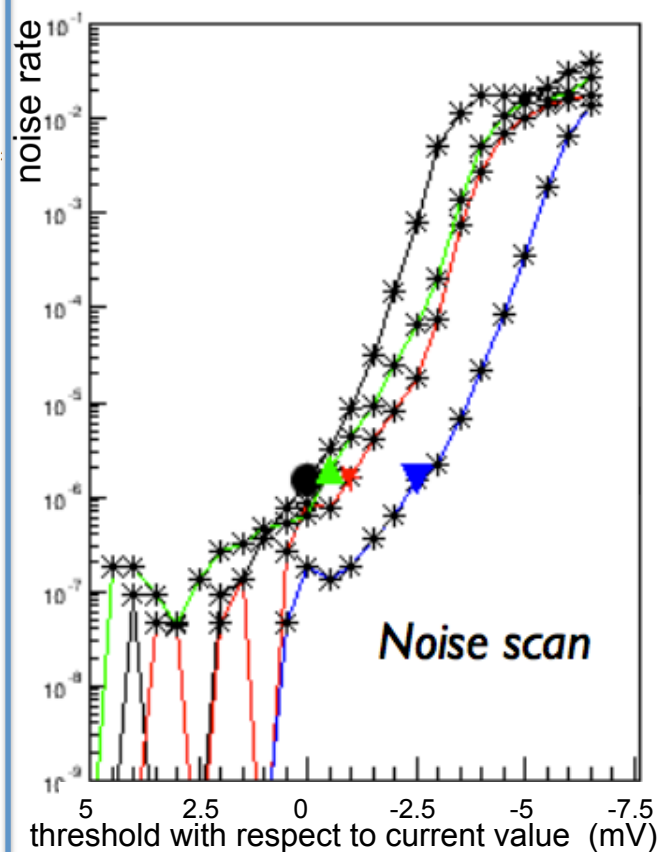

Optimize sub-array thresholds in a
PXL sensor for noise rate = $2.e-6$

- Noise data for PXL and pedestal data for IST and SSD are taken at least once per day without beam, to monitor PXL noise rate, hot pixels, and calibrate IST pedestal.