

HFT Software Status

S. Margetis, KSU

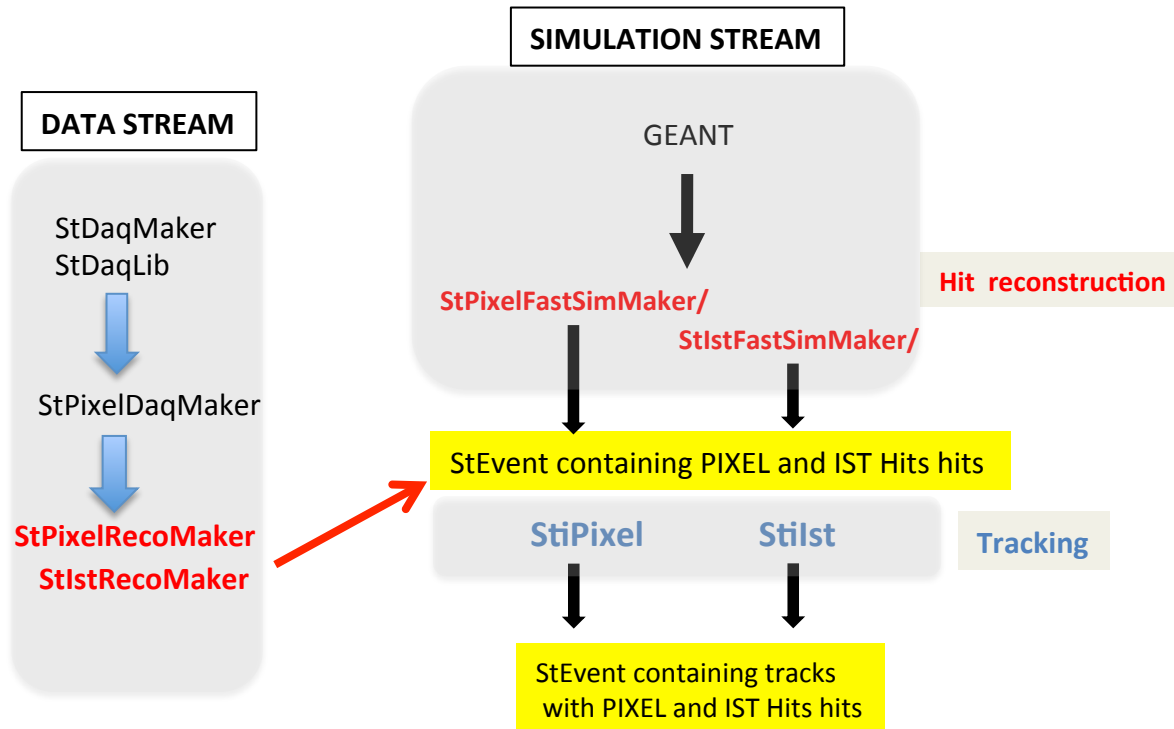

Outline

- Brief overview of subsystem
- Technical Progress since last review
- Construction Plans
- Outstanding technical issues and plans
- Schedule & Cost
 - Cost to date and projection (from Sarah)
- Resources
 - People, institutions and
- Risk assessment; value engineering
- Summary

Overview of subsystem

- WBS 1.6 (Software) is the sum of Online and Offline software tasks
- The Online software is a sub-detector deliverable and contains Slow controls, online monitoring etc
- The Offline software is responsible for the event reconstruction, starting from raw data all the way to particle quantities. It includes tasks like alignment, hit/track/vertex finding etc
- WBS 1.6 is divided into two parts. Part one (on-scope) contains all the essential tasks for the successful operation of the detector (calibrations etc). Part two contains the remaining tasks.
- Subsystem meets weekly to plan work and get updates. Participates in weekly TC meetings as well.
- Subsystem is an integral part of STAR's S&C environment, interacting very closely with it on a regular basis.

General Flowchart of Software Tasks Offline/Online

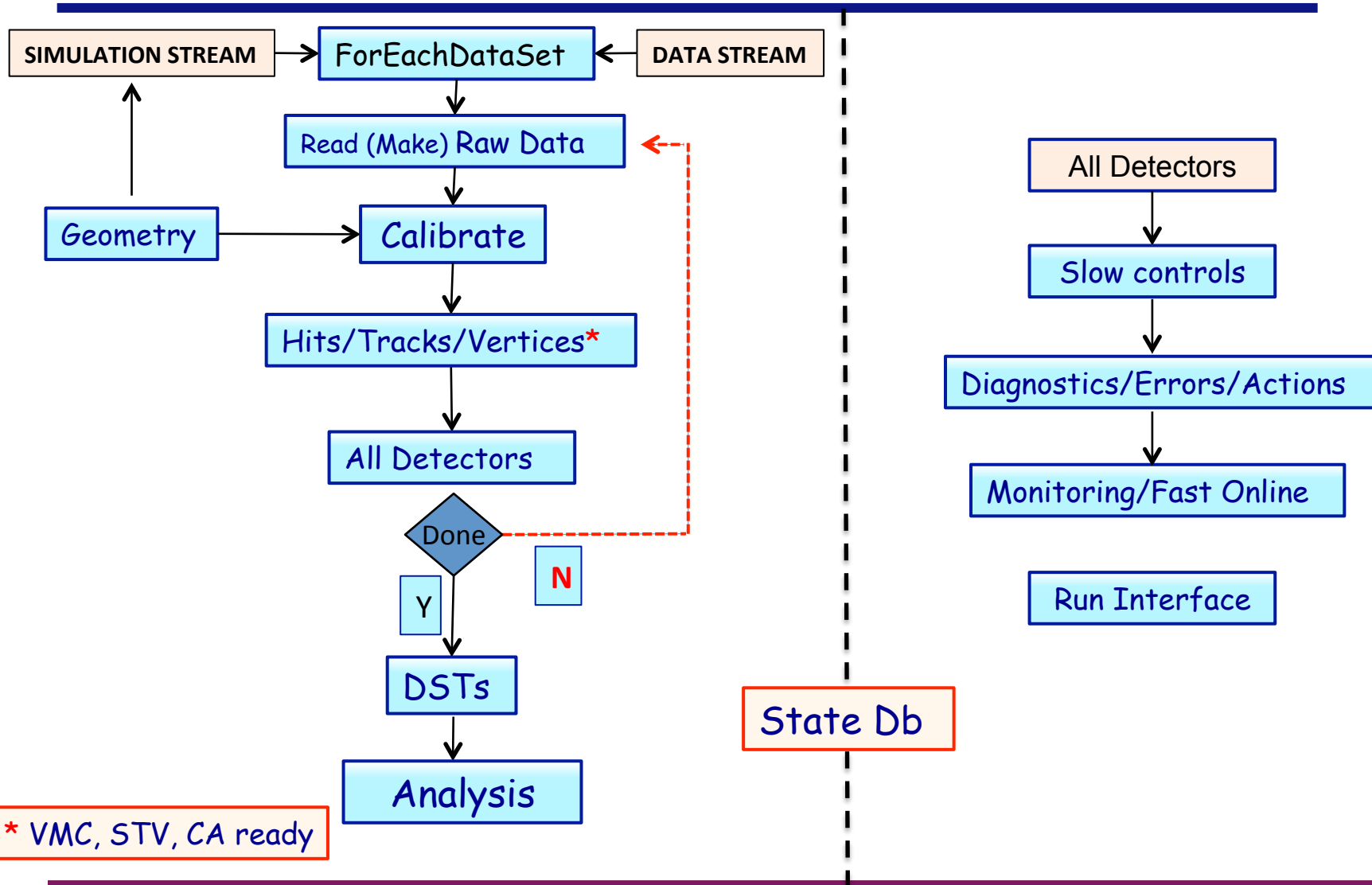

* VMC, STV, CA ready

-
- Brief overview of subsystem
 - Technical **Progress** since last review
 - Construction Plans
 - Outstanding technical issues and plans
 - Schedule & Cost
 - Cost to date and projection (from Sarah)
 - Resources
 - People, institutions and
 - Risk assessment; value engineering
 - Summary

Areas of activities since CD2/3 (a year ago)

RED = On-scope activity

- HFT Geometry model
 - **HFT Survey & Alignment** related work
 - Slow/Fast PXL response simulation
 - Prototype (BUR) simulations/**tracking**
 - Offline structures (Hits etc)
 - Simulation environment (UPC e⁻ background, **Pileup**)
 - Conventions (naming scheme defined), **Db**
-
- **Hit/Event vertex finders/Kalman fitter** for decays
 - Evaluation/Analysis **framework**
 - Tests of new STV tracker, VMC environment
 - **'Online' data format/slow controls/online QA/Db considerations**

HFT Geometry model update

- Creating the Y2013/14 geometry in AgML based on Solid-Works Models
- We had an internal **review** in March, working on recommendations etc
- Work on SSD/IST in [progress](#)
- Work on details of support structures etc in [progress](#)
- Manpower probably O.K. but we seek more help

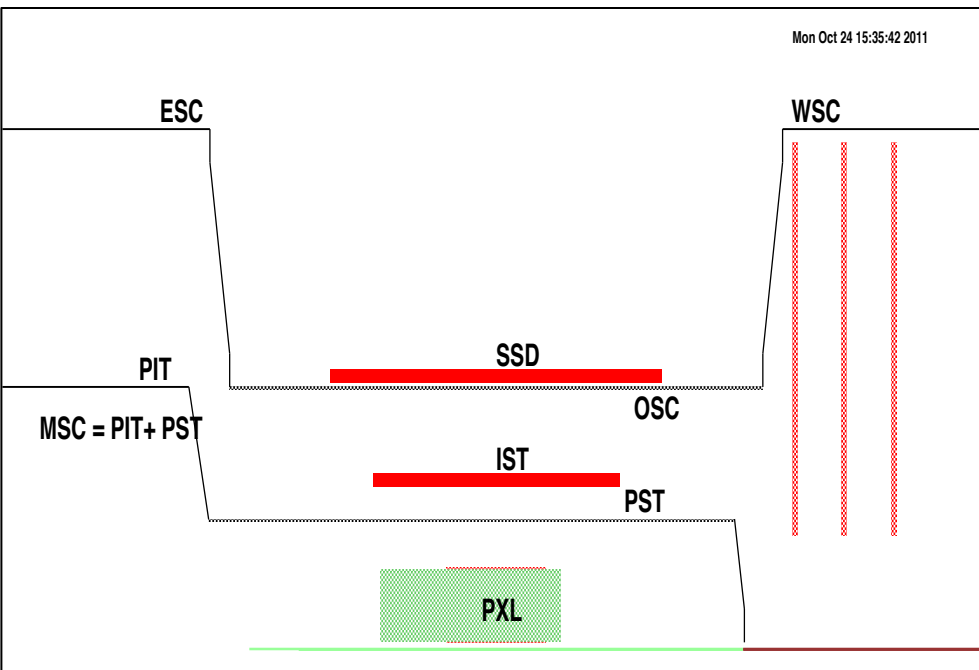

Inner Detector Support

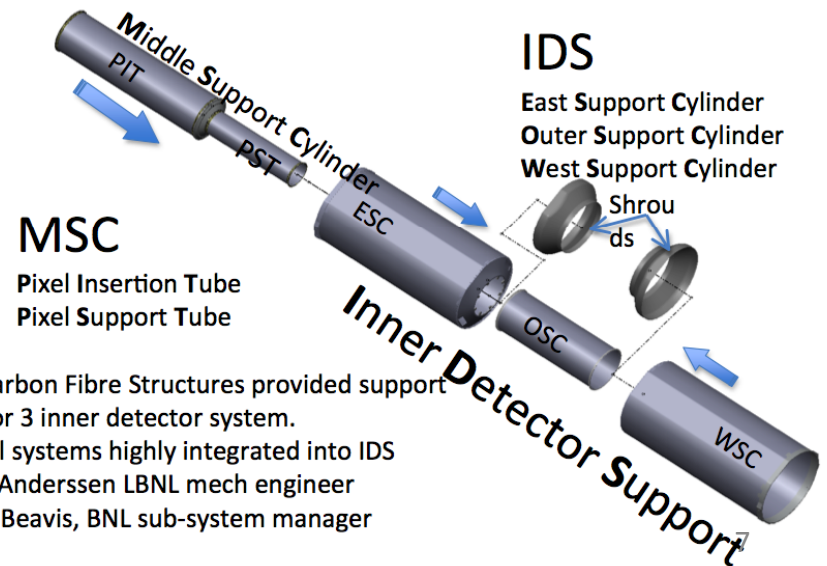

PXL sector modeling in GEANT

- detailed work on structure and thickness (shape and material)
- optimization in progress

GEANT NAME	piece	shape	Composition / mixture	Radiation length [cm]	Density[g/cm ³]
PLAC	Silicon active	box	Si	9.36	2.33
SIFR	Silicon passive	box	Si	9.36	2.33
SIFL	Silicon passive	box	Si	9.36	2.33
GLUA	adhesive	box	O(0.164) C(0.763) H(0.073)	34.7	1.2(*)
GLUB	adhesive	box	O(0.164) C(0.763) H(0.073)	34.7	1.2(*)
GLUC	adhesive	box	O(0.164) C(0.763) H(0.073)	34.7	1.2(*)
ALCA	Aluminum cable	box	Al	23.7(*)	2.7(*)
CBFK	Carbon Fiber backing	box	C	68(*)	1.3(*)

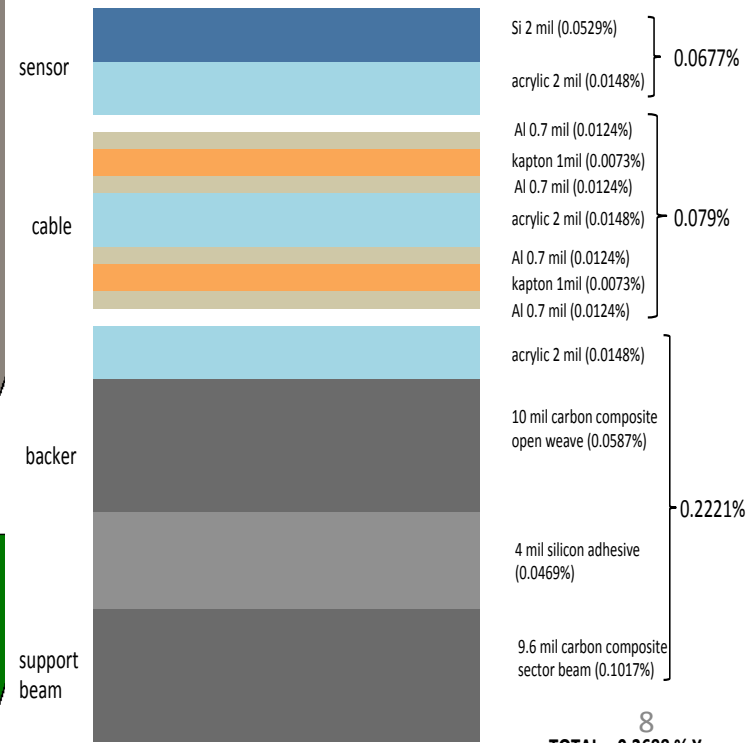
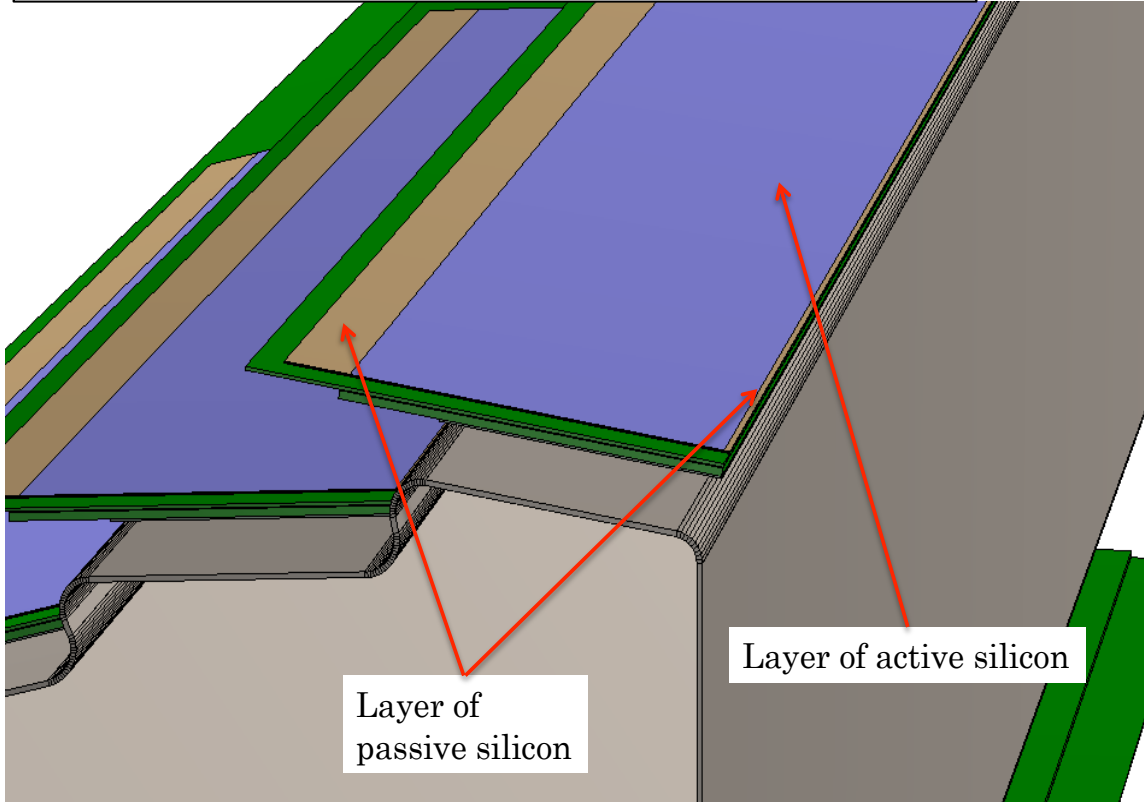
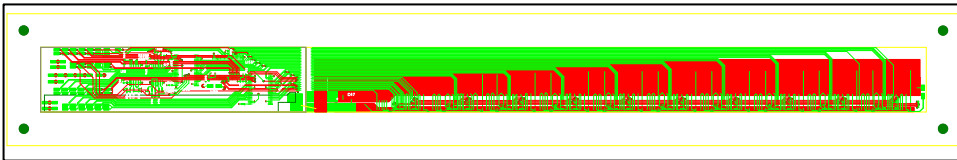

8
TOTAL = 0.3688 % X₀

IDS modeling

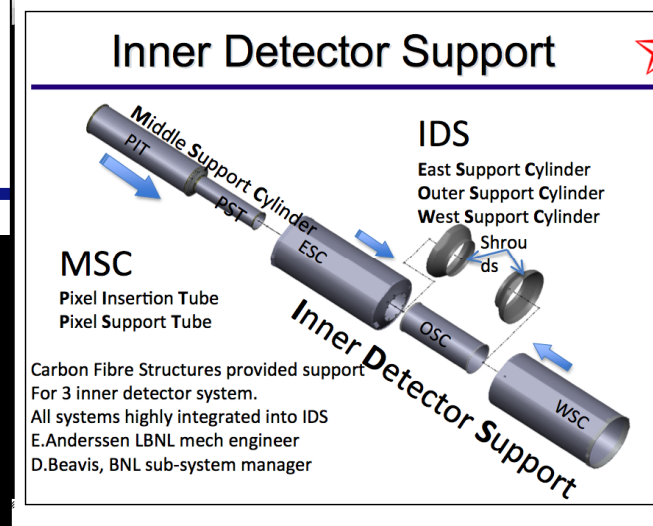
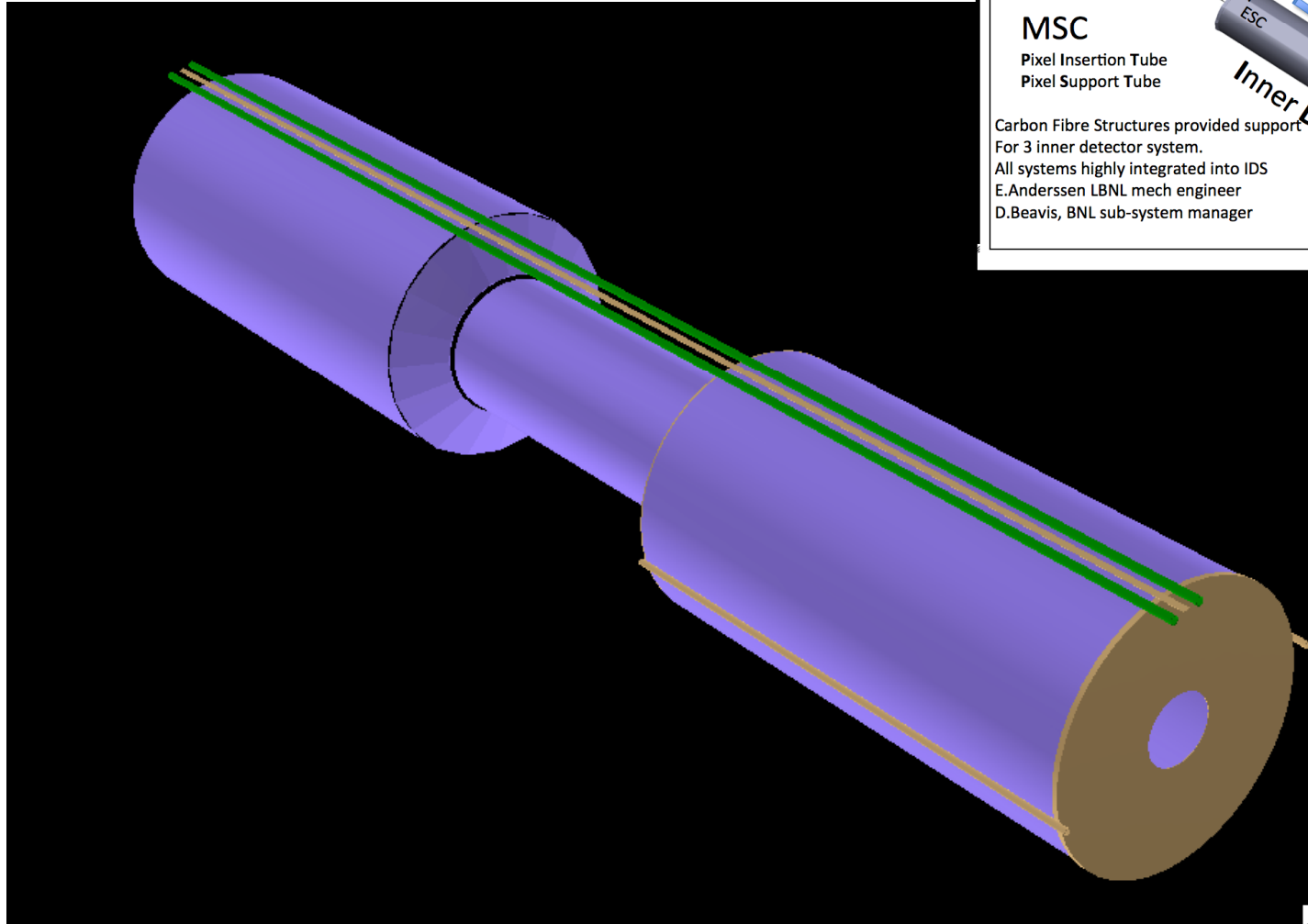

MSC modeling

OVERVIEW OF THE MSC

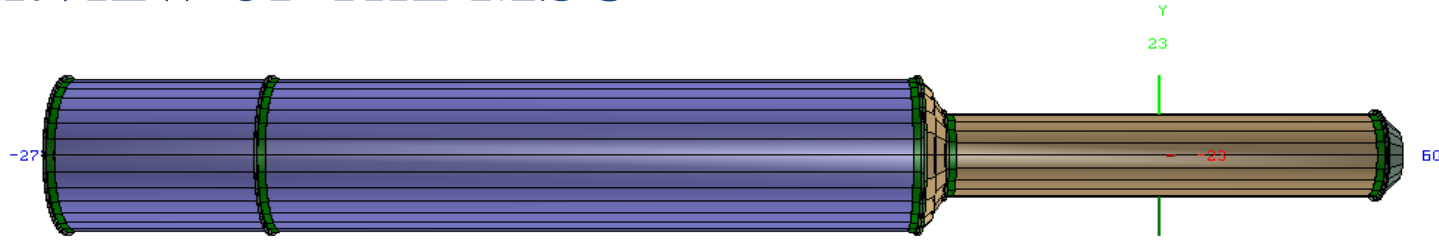

rails

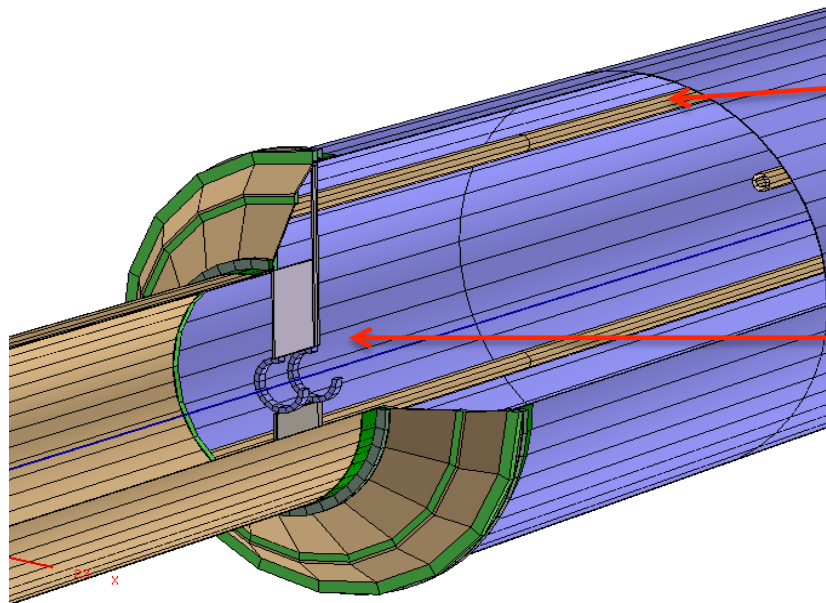

Rings surrounding the beam pipe

•: temporary until implementation of real material (slide 39)

GEANT NAME	piece	Composition / mixture	Radiation length	density
ALL(*)	Carbon Fiber	C	23.9	1.3(*)

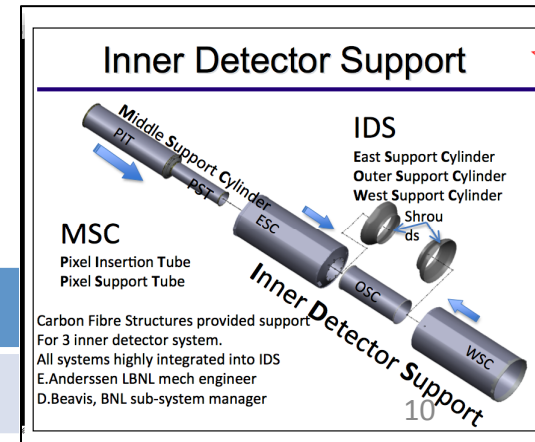

HFT Survey work

- PXL+SSD work has already begun, IST is setting up
 - Single chip and 3-chip ladder done. Full PXL sector (photo) in progress
 - SSD ladder preliminary survey done, parameter space defined
 - IST preliminary work on prototype ladder about to begin at BNL
- We had an internal review on procedures/general scheme in May
- A lot of detailed work in front of us, but expertise is building up
- Manpower issues addressed (most) but there are tasks available

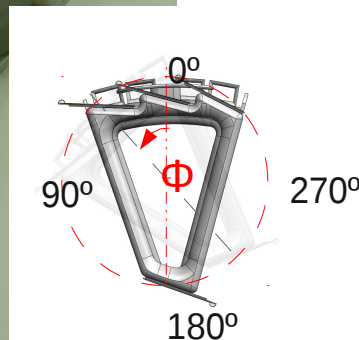
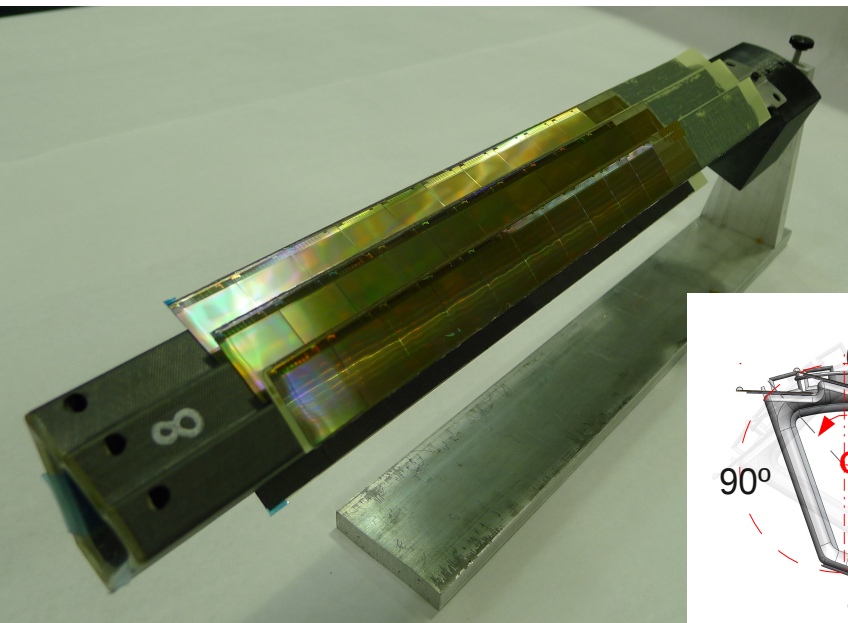

Difference from plane

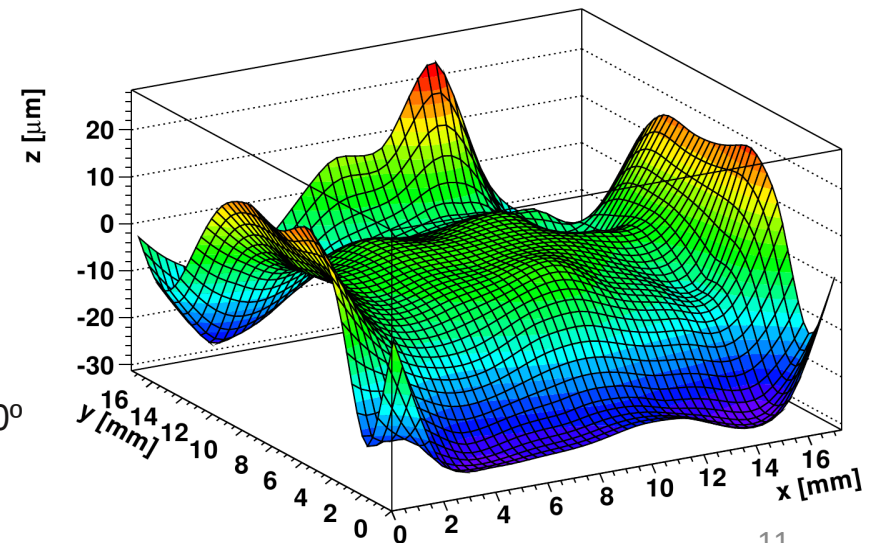

Sensor's features for individual pixel coordinates identified

- Need be programmable for automating process



$x=4594.225 \mu\text{m}$
 $y=10000.00 \mu\text{m}$
 $z=0 \mu\text{m}$

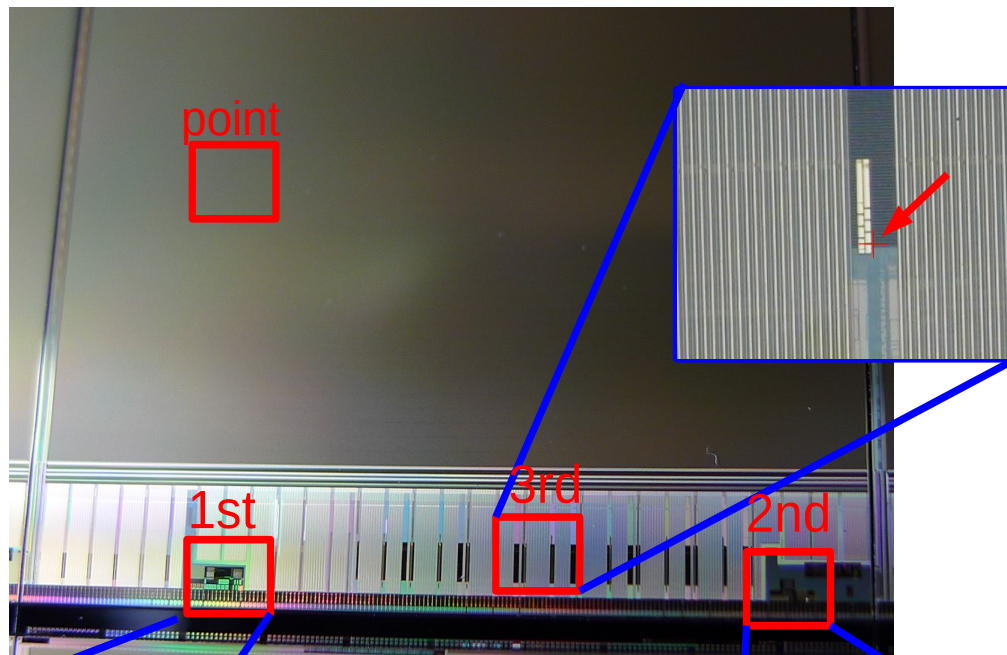

$x=? \mu\text{m}$
 $y=? \mu\text{m}$
 $z=0 \mu\text{m}$

$x=4594.225 \mu\text{m}$
 $y=920.775 \mu\text{m}$
 $z=0 \mu\text{m}$

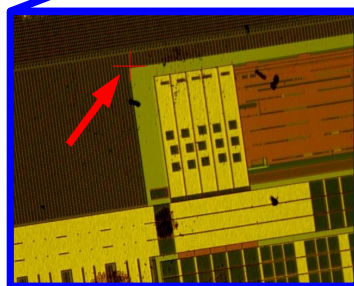

$x=18165.075 \mu\text{m}$
 $y=871.6 \mu\text{m}$
 $z=0 \mu\text{m}$

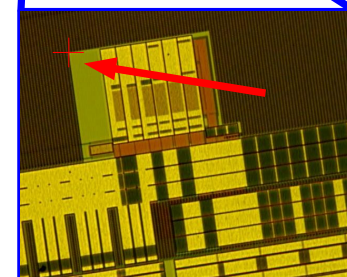

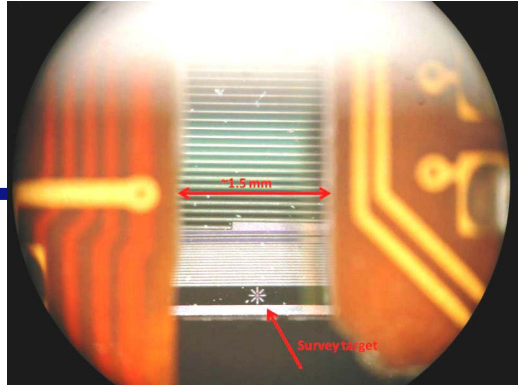
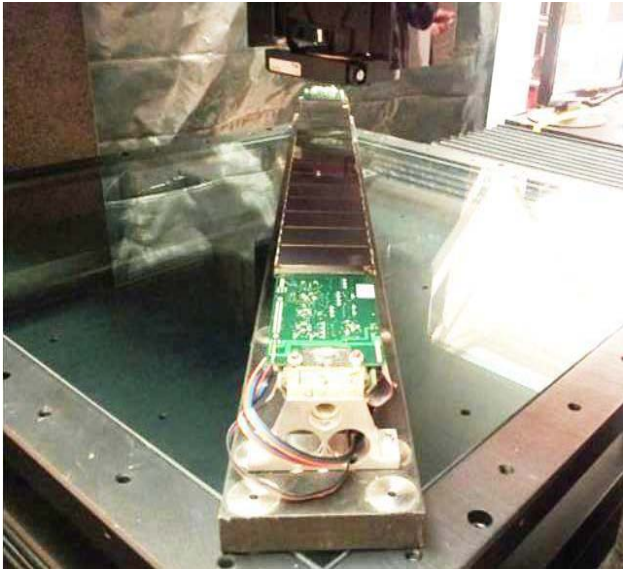

Target on end of wafer (backside)

SSD ladder survey

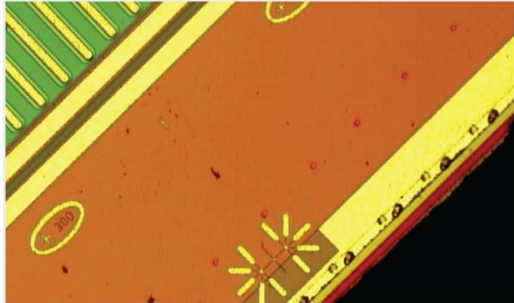

Targets on edges of wafer (front)

Reference point

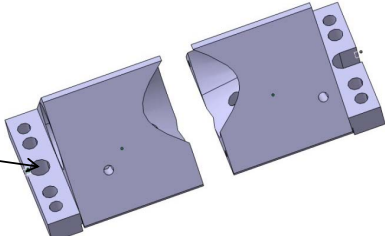

Jim Thomas - LBL

9

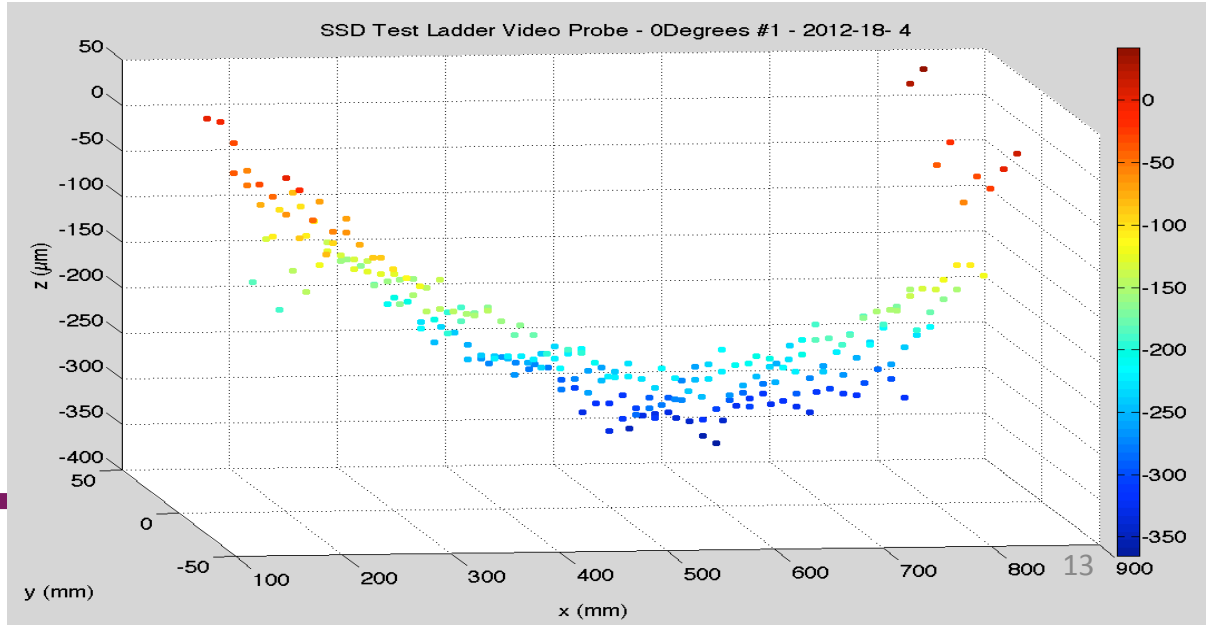

Slow/Fast PXL response simulation

- Most work done by IPHC (Strasbourg) Collaborators
- They have developed a Root program, DIGMAPS, for response studies
- Analyzed CERN test-beam data with our sensors to fix parameters
- We are about to get their tune to use for our studies and compare with default “geometrical mean” approach. Then, build fast simulator with appropriate errors
- SSD simulators exist, IST is relatively simple, but still not there yet
- These are low priority tasks but need to start

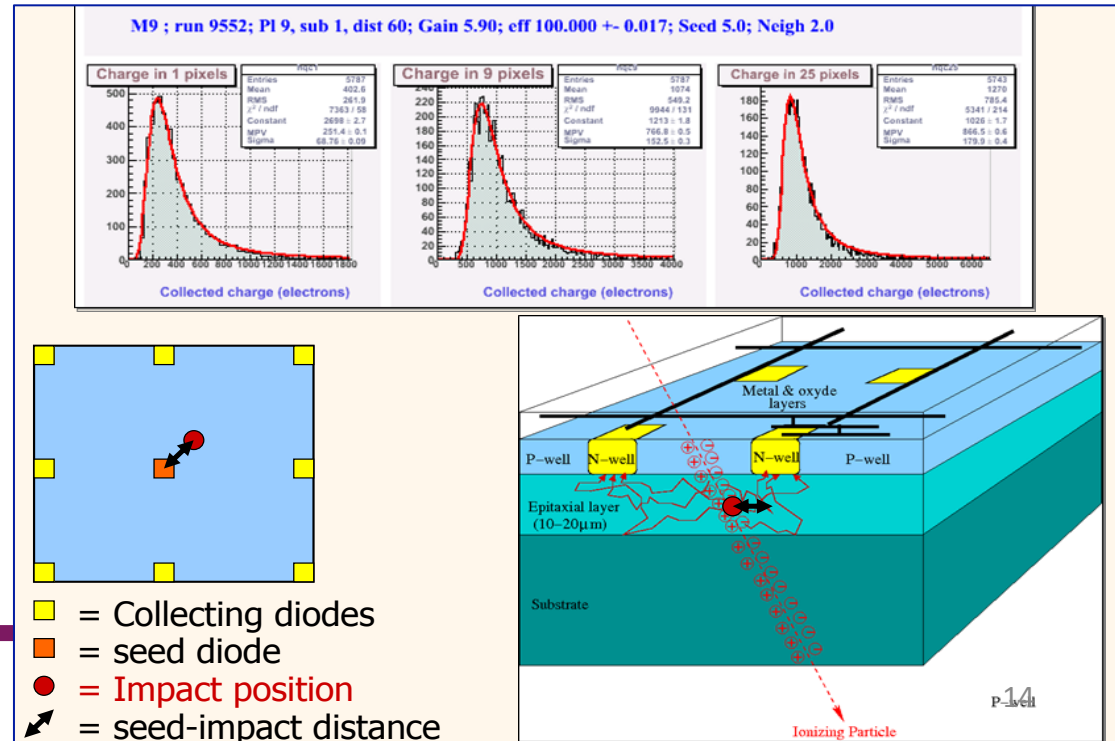
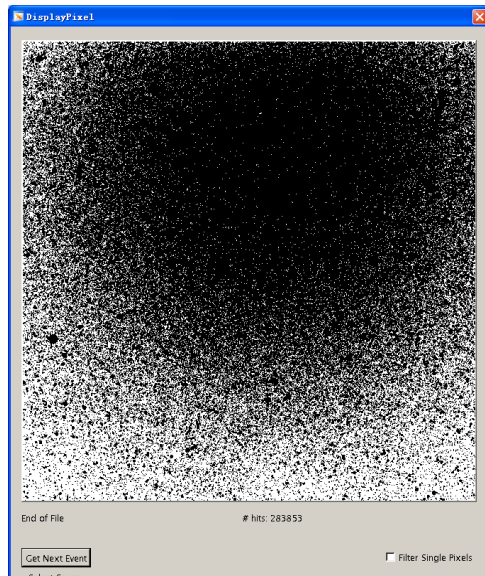

- Tracking (Physics?) with TPC+PXL prototype ?

- BUR simulations done, presented and used as input
- Simulations show (see next slide too) that there might some physics opportunities
- This connects to the bigger issue of Tracking and whether inside-out tracking is possible. Is CA useful? Work in this direction is scheduled
- This is vital work for the project. ANY help and idea is invaluable.

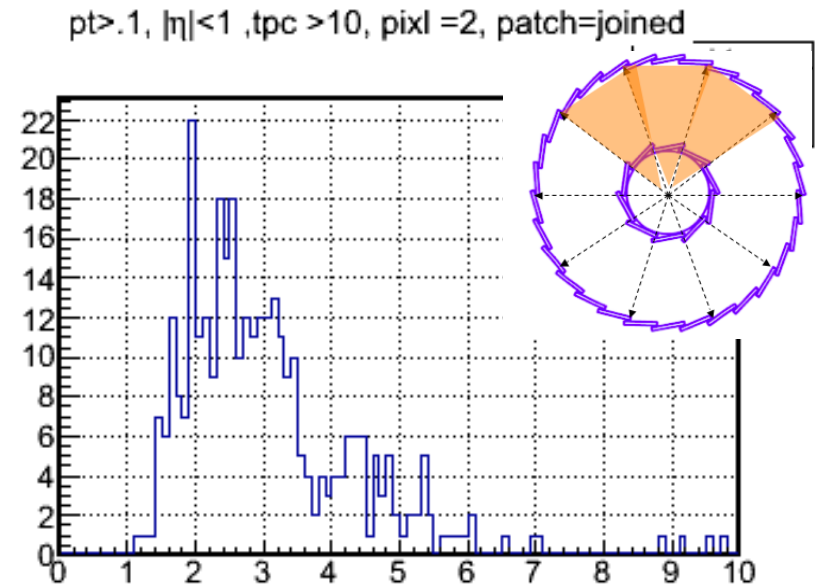
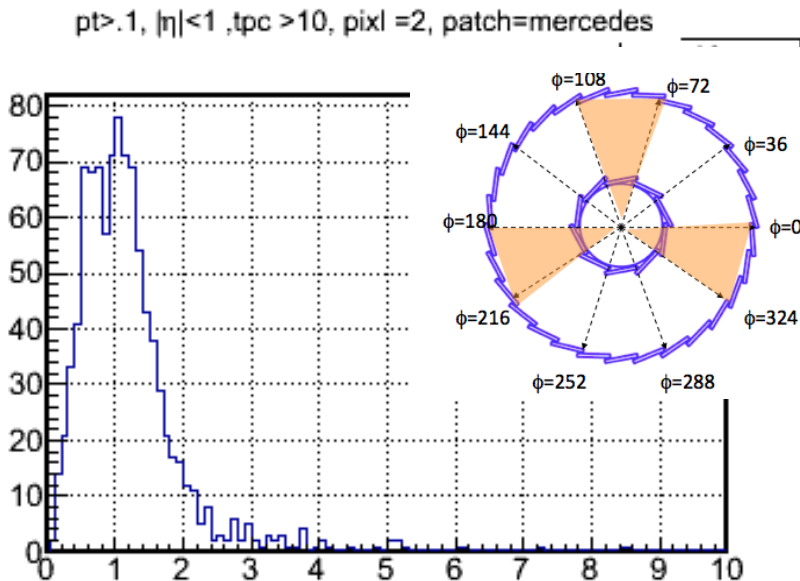

BUR results based on full simulations

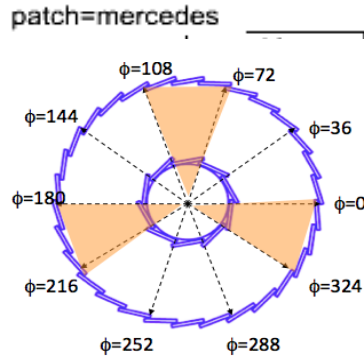

500 M AuAu mbias events

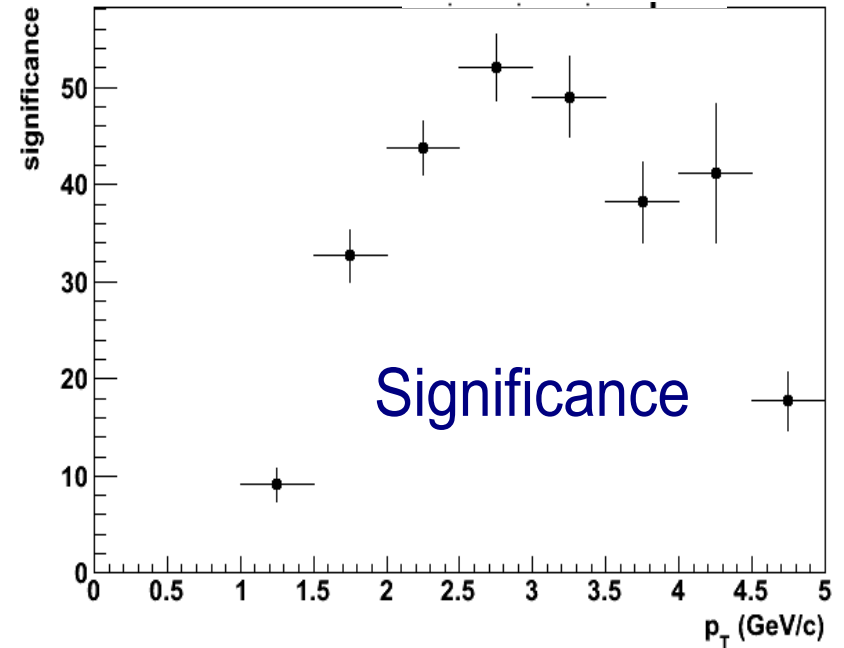
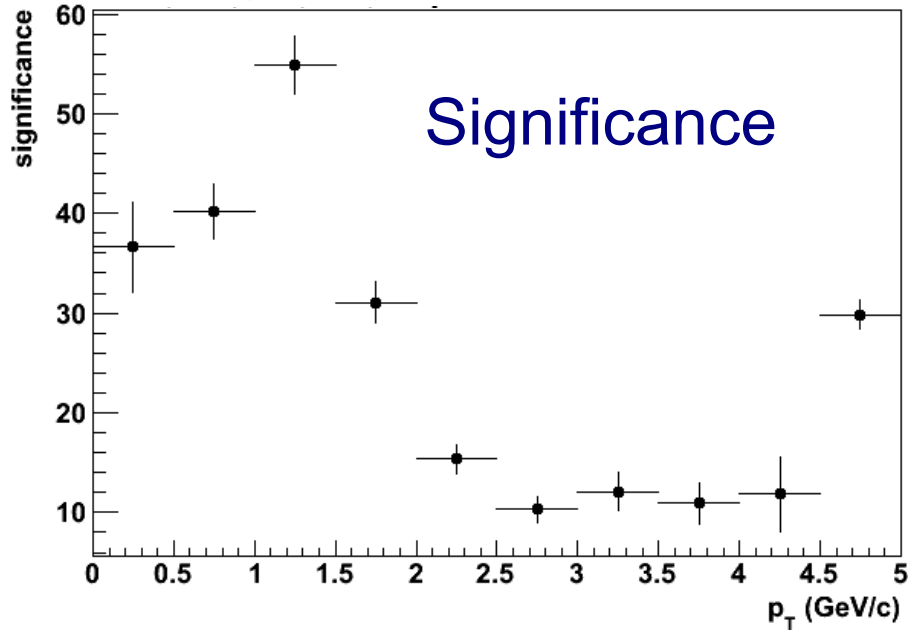
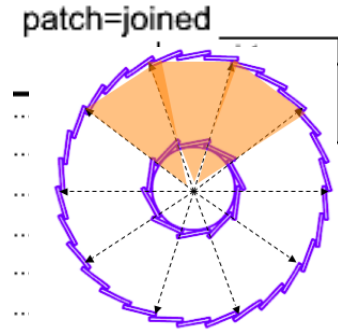

Offline chain - Update

- Establishing a working offline chain
- Modify structures/makers to our needs
- Closely tied to S&C territory !
- Need to stay informed and implement new strategies (e.g. no minimc etc)
- We 've gone through initial loops but not done yet(see 2 slides)
- Expert help invaluable

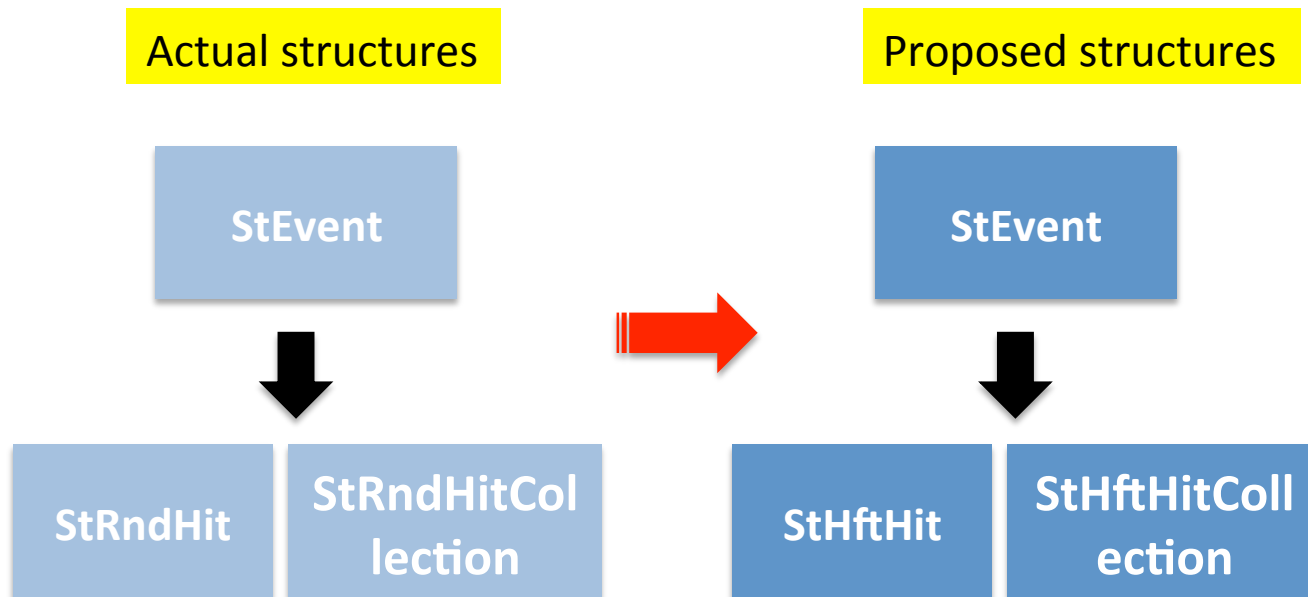

Numbering convention/Configuration of detector elements

- We have defined and documented the scheme for all HFT elements
- Complies with STAR conventions
- IST example is shown below

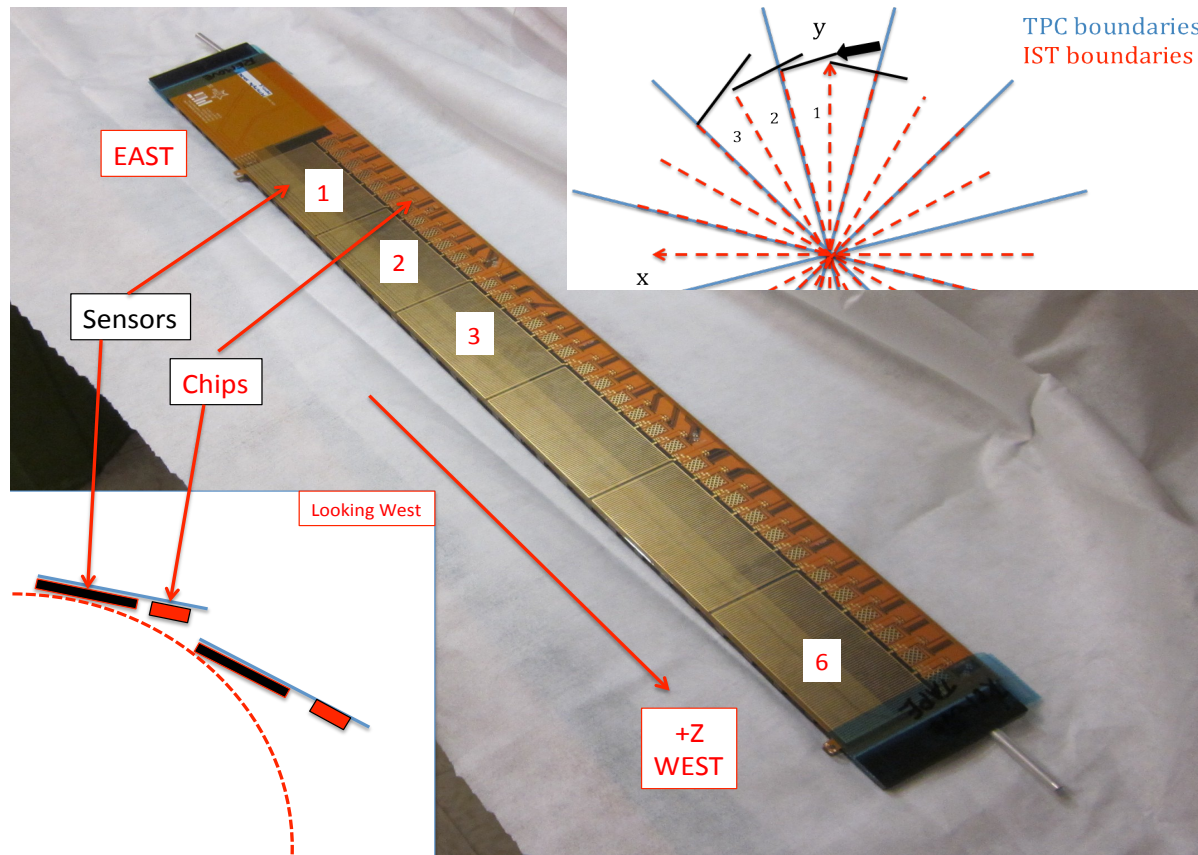

- Simulation environment (UPC e- background, Pileup mechanism)
 - We did improve our understanding and way of generating this
 - We still need to put all this to work with STAR's official pileup scheme
- Event vertex finders
 - Important evaluation work goes on now
- Web Docs
 - Jonathan and I are organizing better our Off-Drupal personal doc areas
 - S&C provided an AFS area for Off-Drupal (really public) access
 - Drupal pages need rework from scratch

-
- Brief overview of subsystem
 - Technical Progress since last review
 - Construction Plans
 - **Outstanding technical issues and plans**
 - Schedule & Cost
 - Cost to date and projection (from Sarah)
 - Resources
 - People, institutions and
 - Risk assessment; value engineering
 - Summary

Planned work to do

- *Besides things I have already mentioned above*
- Raw data un-packers/Cluster-Hit finders
- Tests of CA/new STV tracker, VMC environment
- ‘Online’ data format/slow controls/online QA/Db considerations

With the prototype PXL installation and the new institutional involvement the Collaboration will refocus some of its effort to the new device.

-
- Brief overview of subsystem
 - Technical Progress since last review
 - Construction Plans
 - Outstanding technical issues and plans
 - **Schedule & Cost**
 - Cost to date and projection (from Sarah)
 - Resources
 - People, institutions and
 - Risk assessment; value engineering
 - Summary

Schedule/Milestones

NOW 10/2012



1.6	Software	0%	464 days
1.6.1	Online	0%	464 days
1.6.1.1	PXL	0%	251 days
1.6.1.1.1	metrology conversion into hit point software	0%	20 days
1.6.1.1.2	data format unpacker	0%	17 days
1.6.1.1.3	Slow controls integration	0%	40 days
1.6.1.1.4	error condition lookup action implementation	0%	60 days
1.6.1.1.5	plot generation and analysis of status header	0%	60 days
1.6.1.1.6	L3 - PXL online software ready for engineering run	0%	0 days
1.6.1.1.7	Online Software for production PXL	0%	45 days
1.6.1.1.8	L3 - PXL online software ready for production run	0%	0 days
1.6.1.2	IST	0%	284 days
1.6.1.2.1	Data format unpacker	0%	0 days
1.6.1.2.2	Plot generation single ladder	0%	0 days
1.6.1.2.3	Pedestal software	0%	0 days
1.6.1.2.4	Diagnostic software	0%	0 days
1.6.1.2.5	L3-online software ready for ladder tests tests	0%	0 days
1.6.1.2.6	Update software for IST layer	0%	60 days
1.6.1.2.7	L3 - IST Online Software Complete	0%	0 days
1.6.1.3	SSD	0%	195 days
1.6.1.3.1	data format unpacker	0%	25 days
1.6.1.3.2	Create Online Plots	0%	1 mon
1.6.1.3.4	Create, Program and Test Pedestal Algorithm	0%	20 days
1.6.1.3.5	SSD ready to take ladder data	0%	0 days
1.6.1.3.7	update software for complete SSD	0%	30 days
1.6.1.3.8	L3 - SSD Online Software Complete	0%	0 days
1.6.1.4	Calibration and alignment	0%	464 days
1.6.1.4.1	Survey Software	0%	180 days
1.6.1.4.1.2	CMM analysis software development	0%	9 mons
1.6.1.4.1.1	Test and verify	0%	5 mons
1.6.1.4.1.9	Internal Review of CMM survey software progress	0%	0 days
1.6.1.4.5	CMM analysis	0%	318 days
1.6.1.4.5.1	Analysis of PXL	0%	318 days
1.6.1.4.5.1.10	prototype ladder analysis	0%	3 mons
1.6.1.4.5.1.11	Database entry delivered	0%	0 days
1.6.1.4.5.1.12	production ladders	0%	4 mons
1.6.1.4.5.1.13	L3 PXL Database entry delivered	0%	0 days
1.6.1.4.5.2	Analysis of IST	0%	60 days
1.6.1.4.5.2.5	CMM analysis	0%	3 mons
1.6.1.4.5.2.6	L3 IST Database entry delivered	0%	0 days
1.6.1.4.5.3	Analysis of SSD	0%	60 days
1.6.1.4.5.3.1	CMM analysis	0%	3 mons
1.6.1.4.5.3.2	L3 SSD Database entry delivered	0%	0 days
1.6.1.6	Global Alignment	0%	240 days
1.6.1.6.1	Software Development	0%	12 mons
1.6.1.6.2	Testing phase	0%	11 mons
1.6.1.6.3	L3- Alignment prototype software review	0%	0 days
1.6.1.6.4	L3 - Alignment software for Engineering Run	0%	0 days
1.6.1.8	Self Alignment	0%	240 days
1.6.1.8.9	Software Development	0%	12 mons
1.6.1.8.10	Testing phase	0%	11 mons
1.6.1.8.11	L3- Alignment prototype software review	0%	0 days
1.6.1.8.12	L3 - Alignment software for Engineering Run	0%	0 days

Most immediate activities are in the areas of Online, Calibrations and Offline software

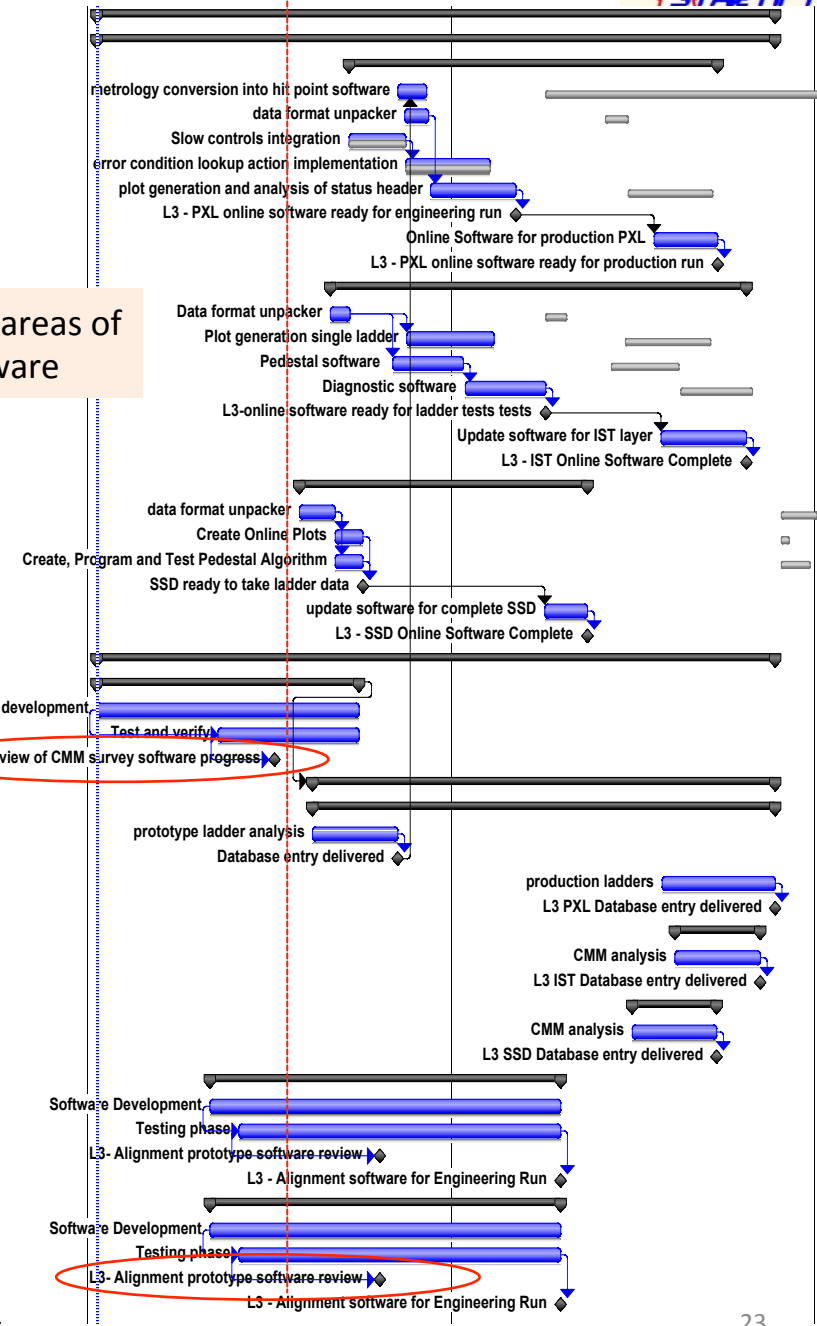

CMM analysis software development
Internal Review of CMM survey software progress

LEVEL-3 Milestones

Software			
3	Review of CMM software progress	4/5/12	5/17/12
3	Alignment software Review	9/20/12	9/20/12
3	PXL CMM database delivered for prototype	11/15/12	11/15/12
3	PXL online software ready for engineering run	12/4/12	12/4/12
3	IST online software for ladder tests	1/13/13	1/13/13
3	Alignment software ready for engineering run	1/18/13	1/18/13
3	SSD online software complete	5/14/13	5/14/13
3	IST online software complete	7/24/13	7/24/13
3	IST CMM database delivered	8/17/13	8/17/13
3	PXL CMM database delivered for production sectors	8/22/13	8/22/13
3	PXL online software ready for production run	10/1/13	10/1/13

- Survey/Alignment/Db/Online are immediate on-project activities
- Geometry/Offline/Analysis are hidden but essential tasks

-
- Brief overview of subsystem
 - Technical Progress since last review
 - Construction Plans
 - Outstanding technical issues and plans
 - Schedule & Cost
 - Cost to date and projection (from Sarah)
 - **Resources**
 - People, institutions and
 - Risk assessment; value engineering
 - Summary

Task Overview and FTE needs

Software task	
Offline	
Hit Reconst.	IST
	Pixel
Tracking	
Event Vertex	
Decay Vertex	
Calibration Db	SSD
	IST
	PXL
Alignment	SSD
	IST
	PXL
Simulation	
Geometry	SSD
	IST
	PXL
Fast/Slow Sim.	SSD
	IST
	PXL
Embed./Pileup	IST
Assoc/Analysis	

- List is for *Offline* tasks only
- Following FTE estimate *does not* include BNL- core group contributed effort in tracking/vertexing/calibrations etc. Also, numbers are on the under-estimate side
- It comes down to about 4 FTE/year for ~two years
 - We have about half of that
 - The rest will come as we near the hardware completion, the prototype development and institutional manpower redirection

Software task		BNL	IPHC	UCLA	KSU	NPI	MIT	LBL	Purdue	USTC
							X UIC			
Offline										
Hit Reconst.	IST						X			
	Pixel							X	X	
Tracking		X	X							
Event Vertex		X	X		X	X				
Decay Vertex		X	X		X	X				X
Calibration Db	SSD	X			X			X		
	IST	X					X			
	PXL	X						X	X	
Alignment	SSD	X			X			X		
	IST	X			X		X			
	PXL	X			X			X	X	
Simulation										X
Geometry	SSD	X			X			X		
	IST	X					X			
	PXL	X						X		
Fast/Slow Sim.	SSD				X			X		
	IST				X		X			
	PXL		X					X	X	
Embed./Pileup	IST				X		X	X	X	X
Assoc/Analysis		X			X	X				

IFT

-
- Brief overview of subsystem
 - Technical Progress since last review
 - Construction Plans
 - Outstanding technical issues and plans
 - Schedule & Cost
 - Cost to date and projection (from Sarah)
 - Resources
 - People, institutions and
 - **Risk assessment; value engineering**
 - Summary

-
- Software Risks (rather Challenges) are related to:
 - People: (in)sufficient manpower for tasks
 - We are addressing this by prioritizing tasks and management actions
 - Overall environment functionality (tracking etc)
 - We engage in discussions with STAR S&C management for overall timeline development/understanding
 - Our value engineering is to use field-proven techniques

Summary



- ...