

# Software Update

(since LBL TC meeting in May 2010)

S. Margetis, KSU

# Content

- HFT-Physics PR
- Some notes on PXL Alignment procedure
  - Structures, fits, some results
- Simulations Updates, ie getting ready for CD2/3
  - $B \rightarrow J/\Psi$
  - $D_s \rightarrow \Phi + \pi \rightarrow KK\pi$
  - $D^+ \rightarrow K\pi\pi$
  - Other (refinements etc)
- Progress on WBS, Schedule and Resources

## Some HFT talks in Int. Conferences

- **ExcitedQCD2010.**
  - Proceedings to appear in Acta Phys. Pol. B, Vol. 3
- **BEACH 2010**
  - Proceedings to appear in Nuclear Physics B - Proc. Suppl.

# Notes on PXL Alignment

E. Andersen, B. Connors, S. Margetis, M.  
Szelezniac, X-M Sun, H. Wieman + A. Quintero

# Outline

- The software structures in CVS repository
- The CMM
  - The tools and the accuracy
- Sample Data
  - Format
  - Code to manipulate it/reformat
  - Code to analyze it
- Outline of PXL survey procedure
- Deciding on best approach to parametrize/save/use the CMM info

# CVS Tree Structure

```
• % dtree hft
• /star/institutions/ksu/margetis/hft/calib/hft
• '-----CVS
• '-----ist
• | '-----CVS
• '-----pixel
• | '-----calib
• | | '-----alignment
• | | | '-----CVS
• | | | '-----global
• | | | | '-----CVS
• | | | '-----local
• | | | | '-----CVS
• | | '-----CVS
• | | '-----survey
• | | | '-----CVS
• | '-----CVS
• '-----ssd
• | '-----CVS
• '-----StRoot
• | '-----CVS
• | '-----StHftPool
• | | '-----CVS
```

rcas6012 % dir hft/pixel/calib/survey

```
CVS/
Ball_test_30.dat
Ball_test_8.dat
f3d_minuit30.C
```

# Development of spatial map-Tools

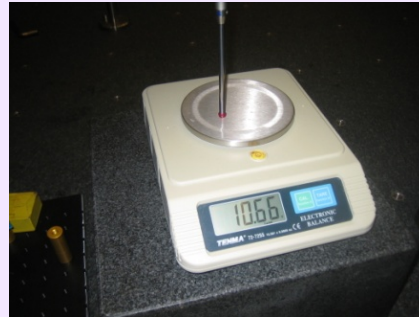

10 gr touch probe force

touch probe 2-3  $\mu\text{m}$  (xyz) and visual 2-3  $\mu\text{m}$  (xy) 50  $\mu\text{m}$  (z)

active volume: huge

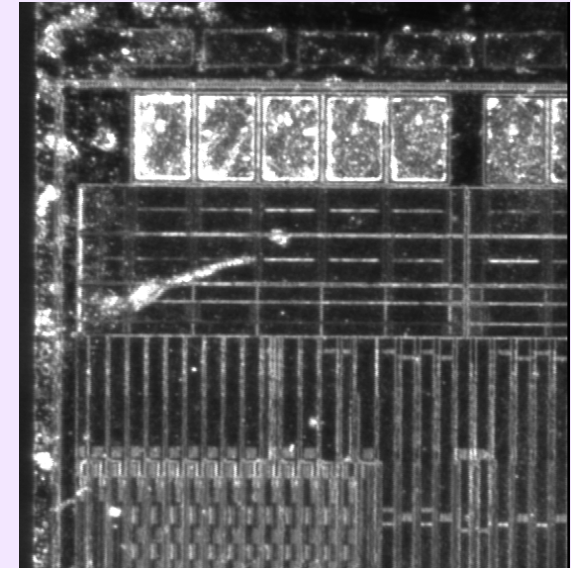

**MEMOSTAR3, 30  $\mu\text{m}$  pitch**

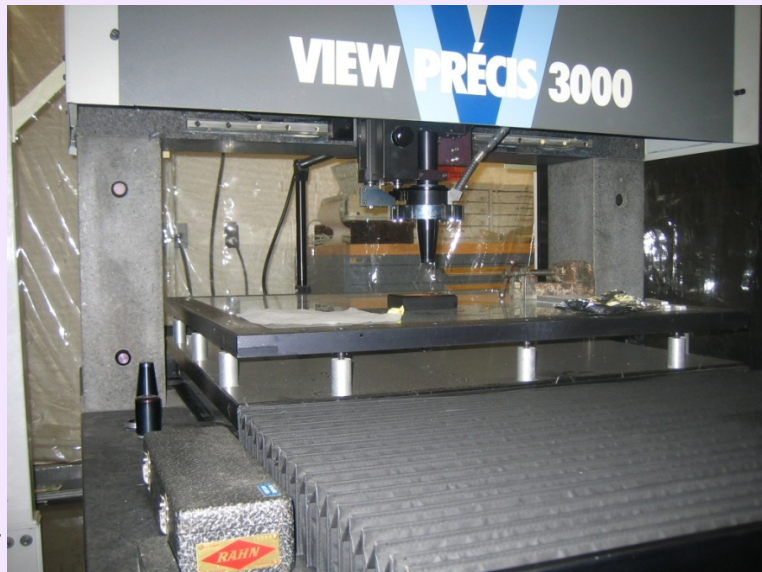

visual sub micron (xyz)  
repeatability  
5  $\mu\text{m}$  accuracy over active volume

no touch probe

active volume:  
30 in X 30 in X 12 in

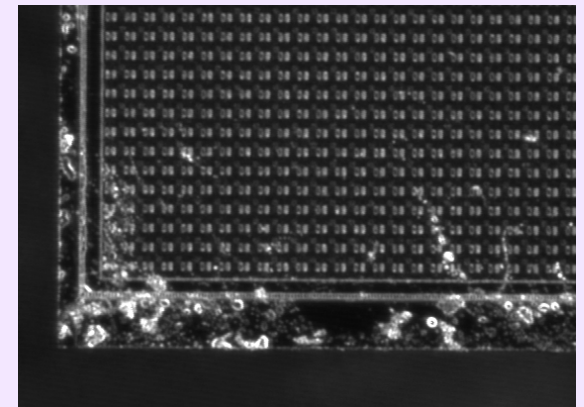

# Data format

x	y	z
3.999321027720	-0.001003938440	-0.000767819730
3.998206983736	0.014041189594	0.009140107333
3.999429581487	0.486586482457	0.046341350006

sx	sy	sz	ux	uy	uz	R
6.00099313695	-0.00100393844	-0.00076781973	-1.00000000000	0.00000000000	0.00000000000	2.00167210923
5.99979712073	-0.00110194800	-0.00080181117	-0.99995904812	0.00756524384	0.00496680673	2.00167210923
5.99115111246	0.29322055711	-0.00209618567	-0.99502886701	0.09660219796	0.02419853654	2.00167210923

$$(x,y,z) = (sx,sy,sz) + (ux,uy,uz)*R$$

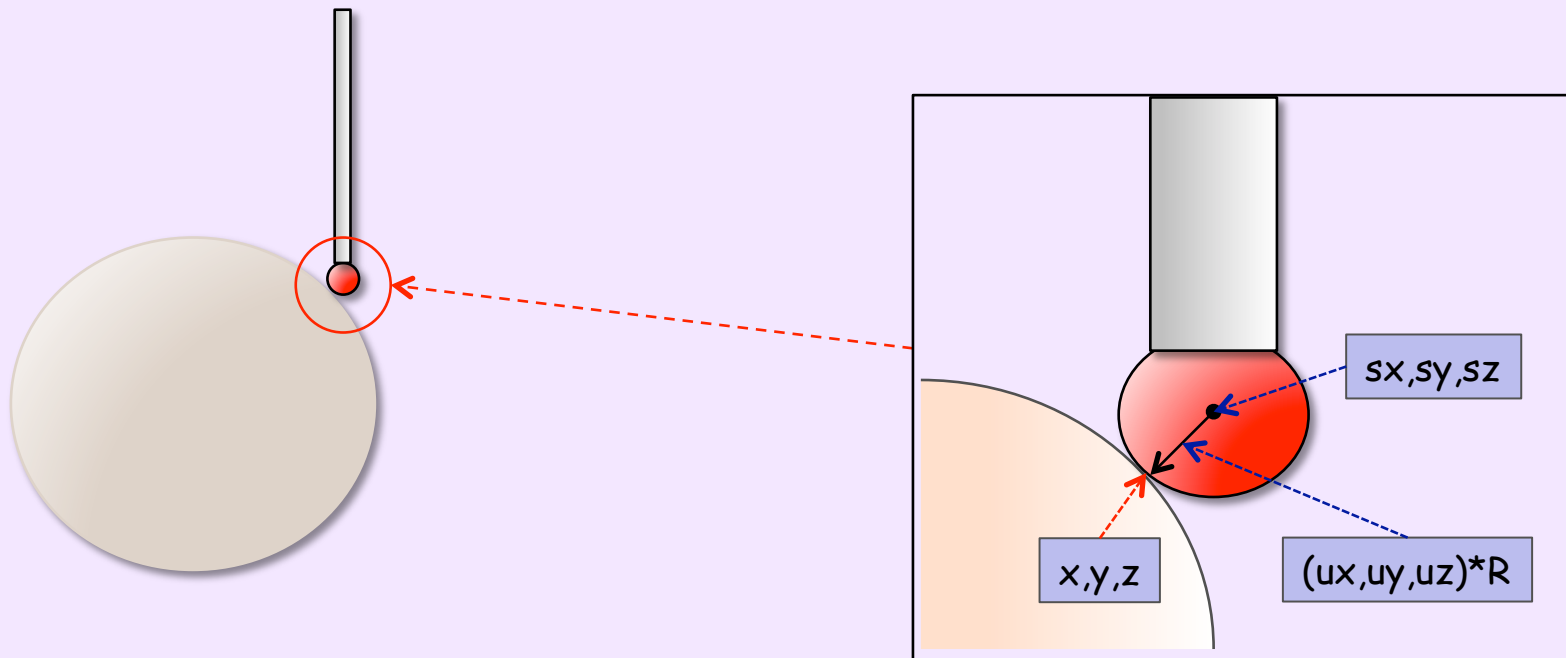



# Calibration Spheres (testing Minuit)



```

FCN=36.4003 FROM MIGRAD STATUS=CONVERGED 107 CALLS 108 TOTAL
EDM=1.02353e-06 STRATEGY= 1 ERROR MATRIX ACCURATE
EXT PARAMETER          STEP    FIRST
NO. NAME  VALUE  ERROR  SIZE  DERIVATIVE

1  xf  -5.73114e-03  8.27066e-03  2.44789e-05  1.09050e-01
2  yf   1.35134e-02  8.65680e-03  2.57509e-05  5.48783e-02
3  zf   6.34039e-02  1.89585e-02  3.88144e-05  7.15526e-02
4  Rf   4.05756e+00  7.92489e-03  1.61366e-05  2.07723e-01
    
```

```

1  xf  -8.35720e-04  2.10848e-03  7.63920e-06  -5.48718e-01
2  yf   6.21893e-03  2.22810e-03  8.63916e-06  7.17852e-01
3  zf   8.36591e-02  2.89518e-02  1.04172e-04  -3.53446e-01
4  Rf  15.0157e+00  1.53222e-03  7.16006e-06  1.63462e-01
    
```

Scale in mm

val1:val2:val3

R = 4 mm Ball

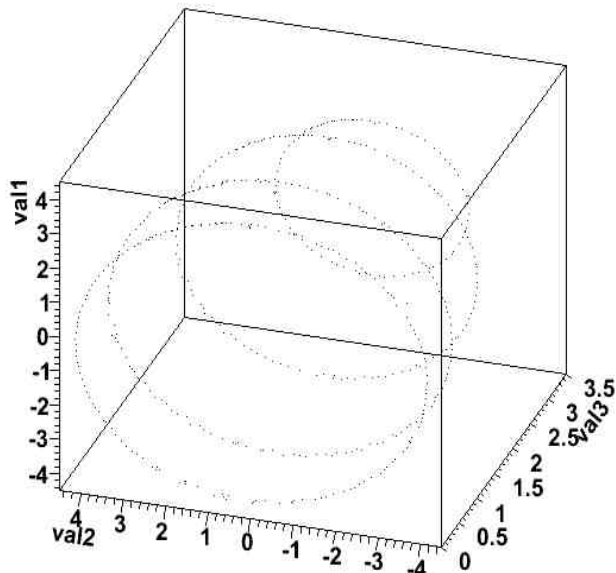

Looks fine

# Test survey of a PXL naked sector (no chip)





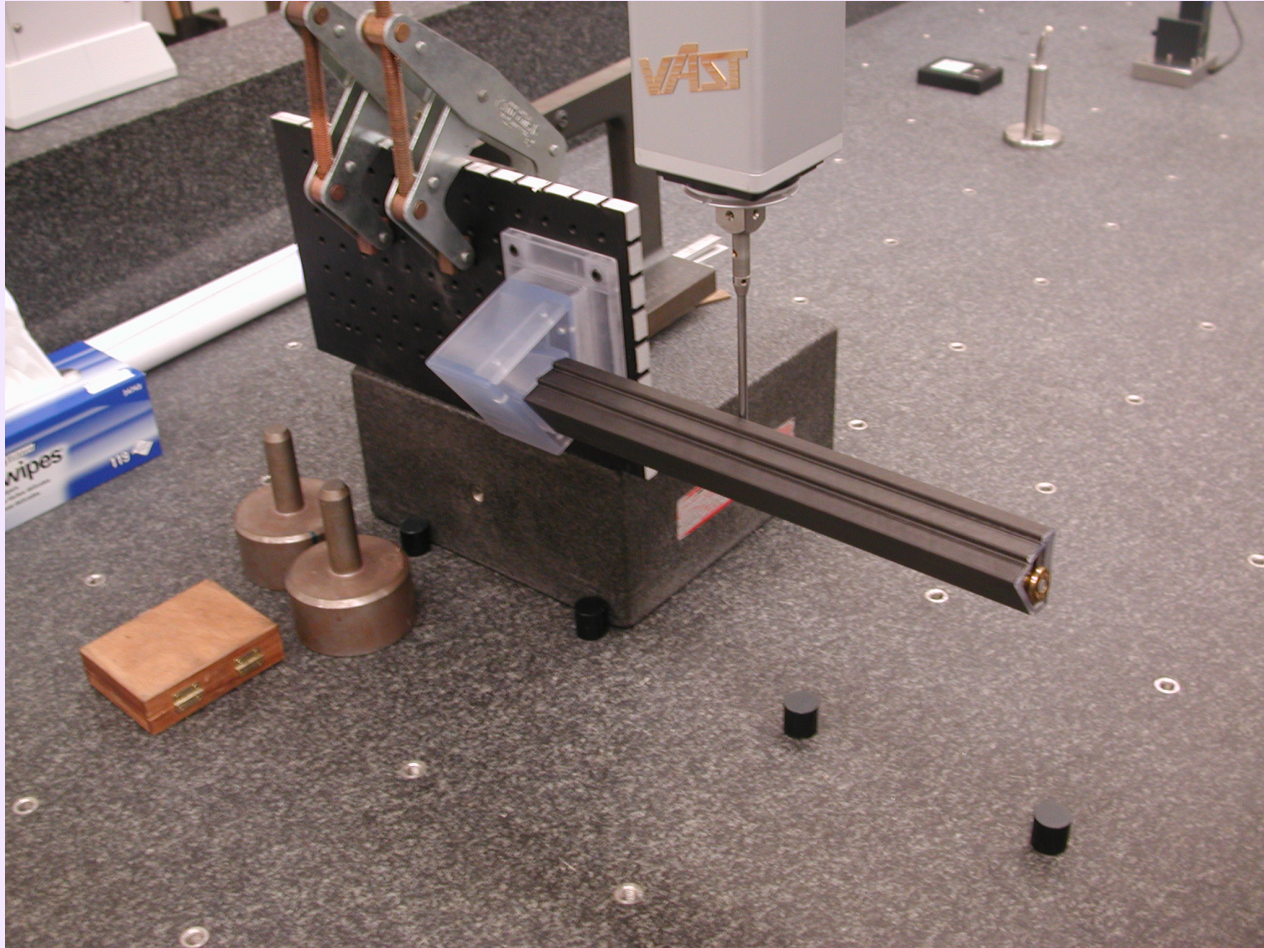

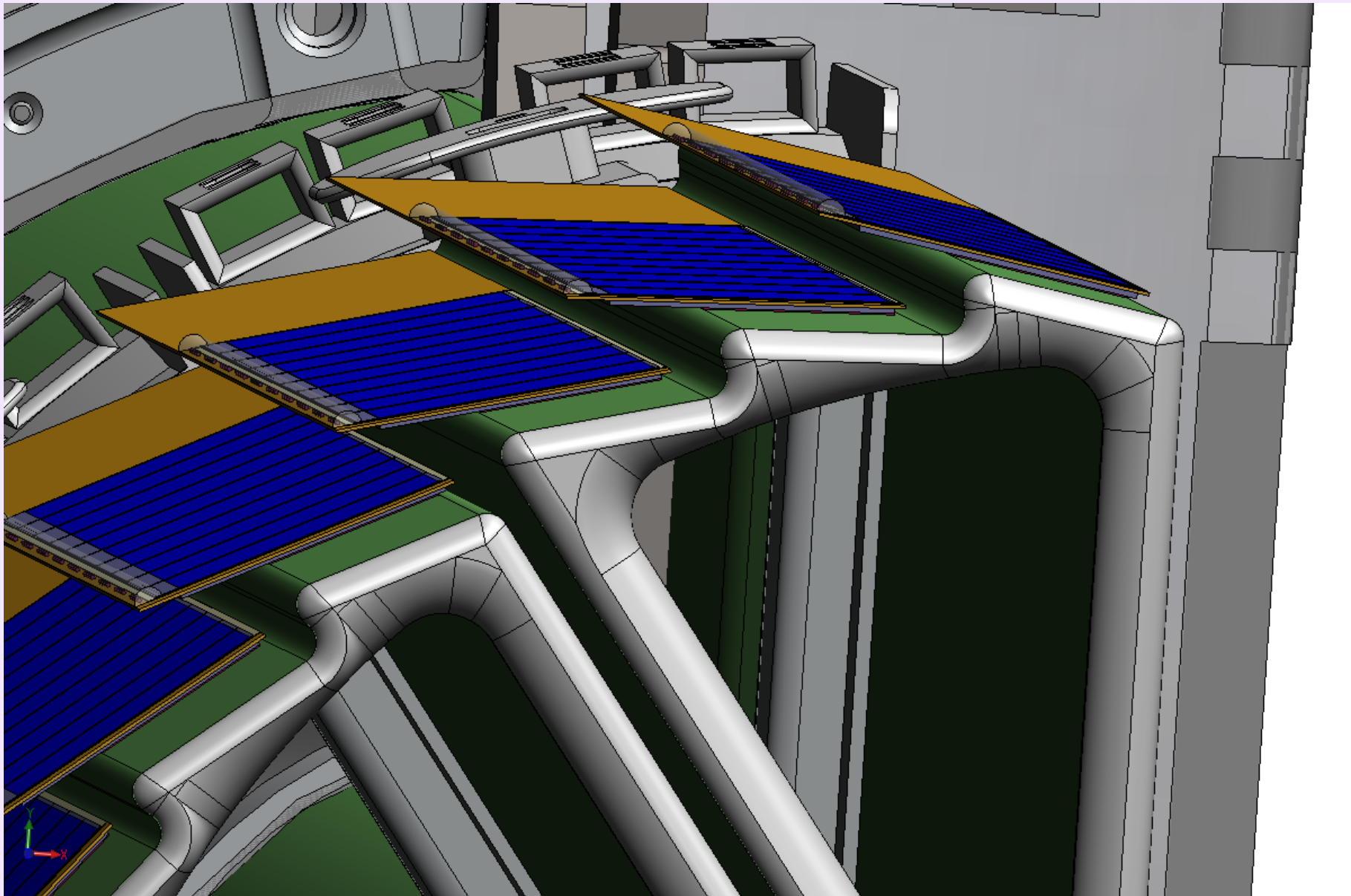

Visualization of touch probe data in solid works  
Coordinate Measuring Machine gives touch probe ball location plus a unit vector in the direction of the touch force. This figure shows ball location plus ball radius times unit vector.

Michael and Xiangming have developed code for putting coordinate machine data into more convenient form

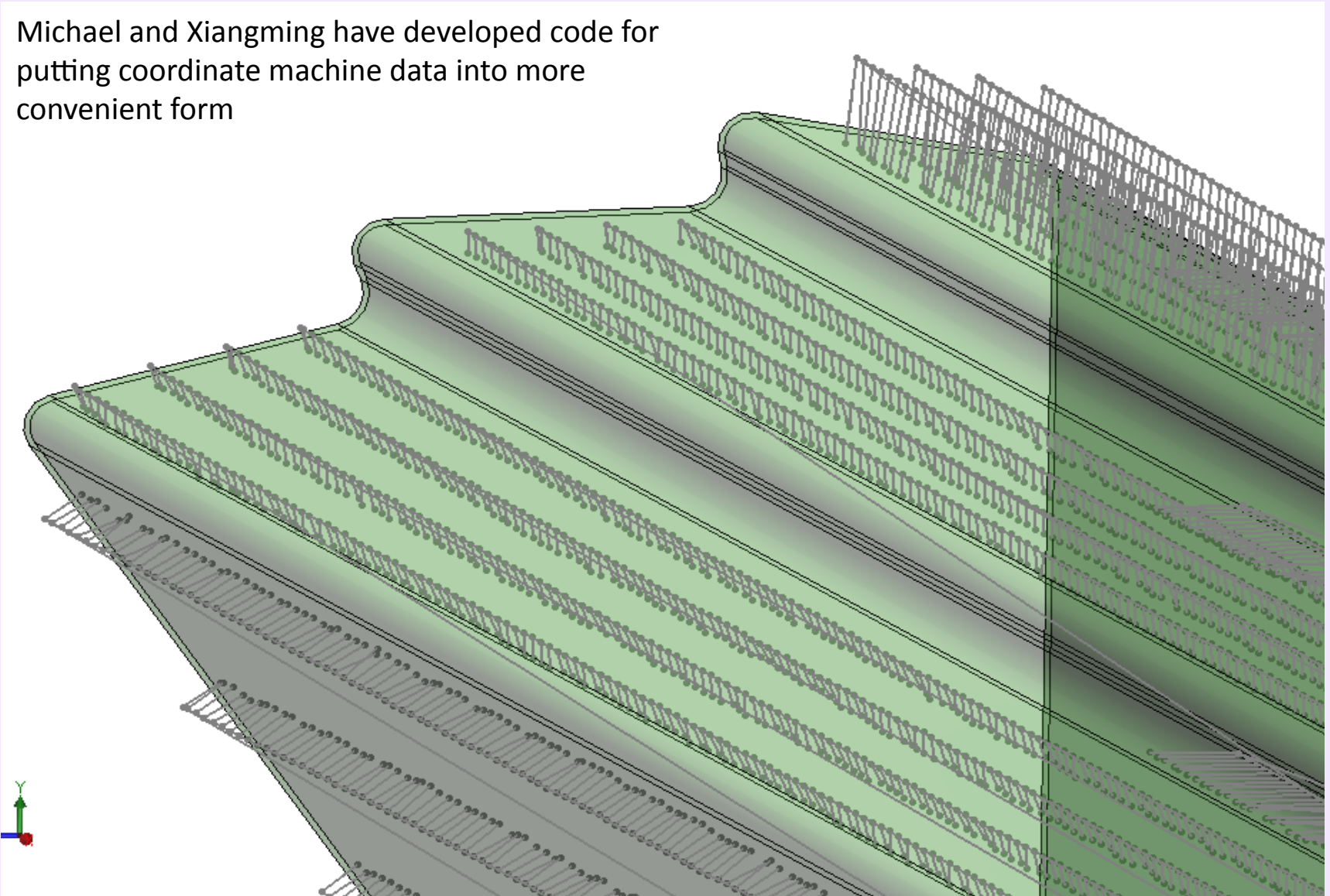



## Testing/playing with plane fitting in Minuit

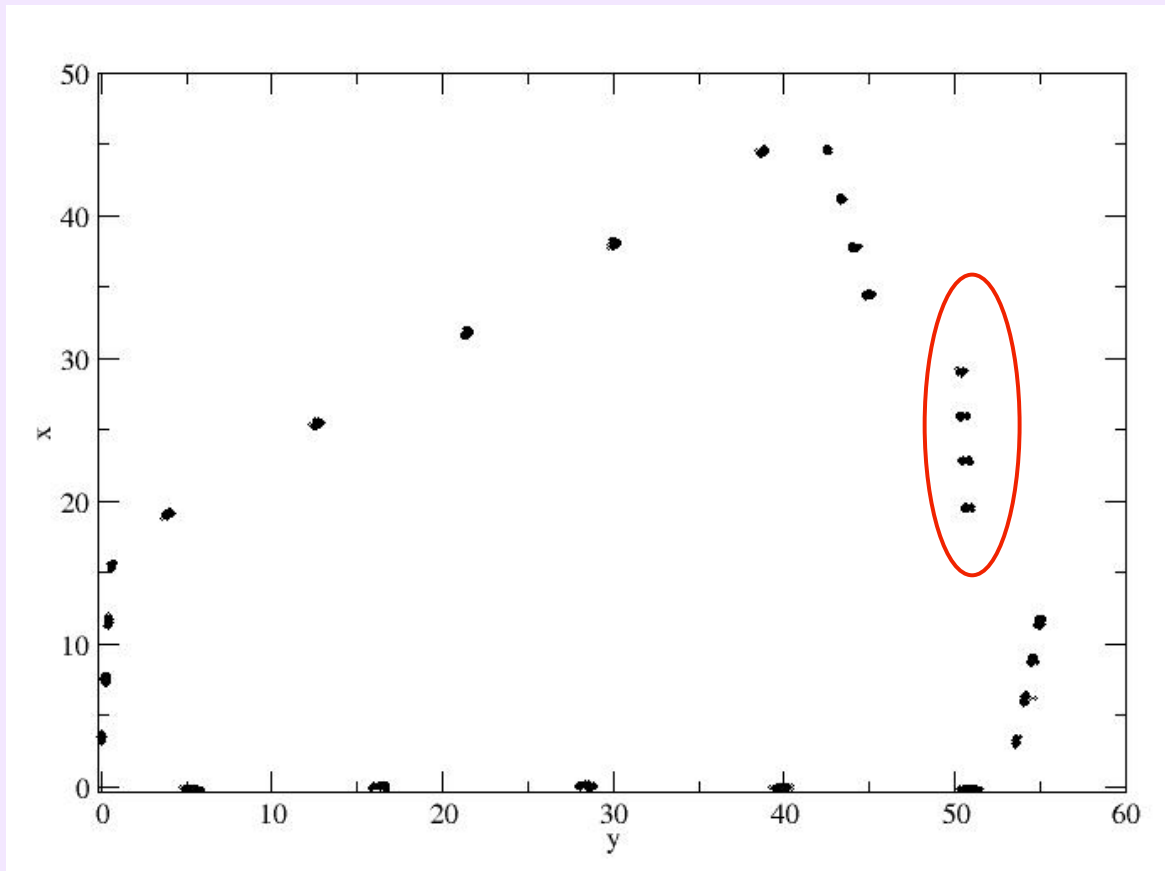

- This is not the actual chip surface
- Surface irregularities much bigger than machine errors

We would need to take measurements with mock/real chips on to decide on method:  
- fitting, interpolation ?  
- good tolerance (plane shift by  $d$  results in  $d \cdot \sin\theta$  hit shift in plane) . For  $d=100 \mu\text{m}$  and track angle of 5 degrees the shift is  $9 \mu\text{m}$

# Carbon surface (testing Minuit-2)

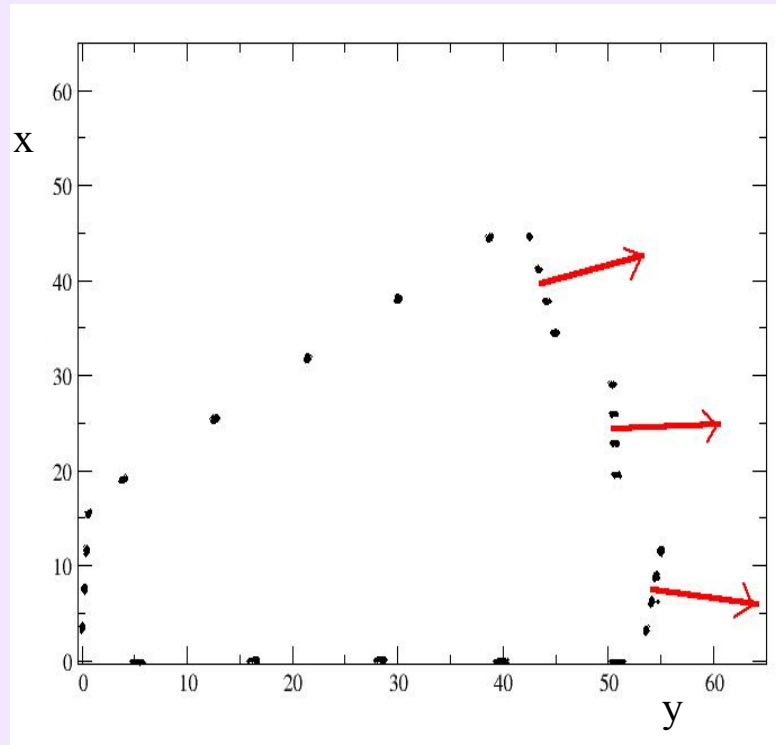

1	nx	2.79475e-01	6.72162e-03	2.78590e-06	-1.50675e-01
2	ny	9.60266e-01	2.00140e-03	8.29867e-07	-5.52819e-01

1	nx	3.56700e-02	1.00150e-02	1.00693e-05	2.11277e+00
2	ny	9.99381e-01	4.00012e-04	4.76542e-07	5.77249e+01

1	nx	-1.60589e-01	1.09483e-02	1.37988e-06	-1.34132e+00
2	ny	9.87121e-01	1.78981e-03	4.70696e-07	1.35967e+01

- Carbon surface is too rough for accuracy estimations
- Plane fits likely to be combined with Gaussians or ?? in order to accommodate surface/glue bumps

Model name: sector analysis  
Study name: Study 1  
Plot type: Static displacement Displacement1  
Deformation scale: 3590.25

## Simulation with 40gr ? weight

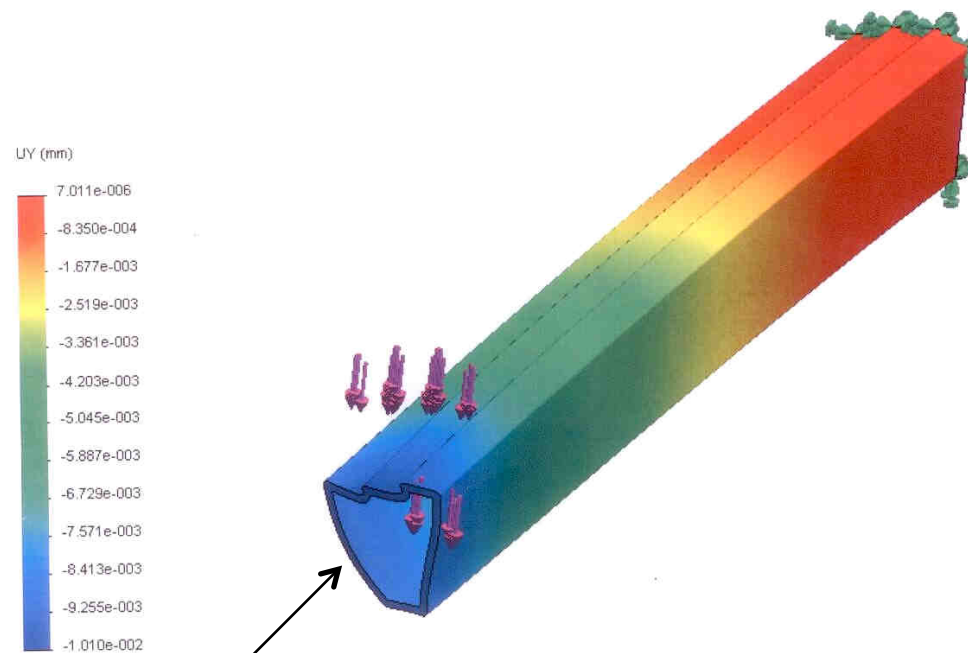

8-10 microns

- Expect average deviations from plane fits 4-5 micron
- CMM files say 100 gr weight was used (more deflection)
- To be done



Prototype fixture...also used for supporting half cylinder for CMM mapping of PIXEL surfaces

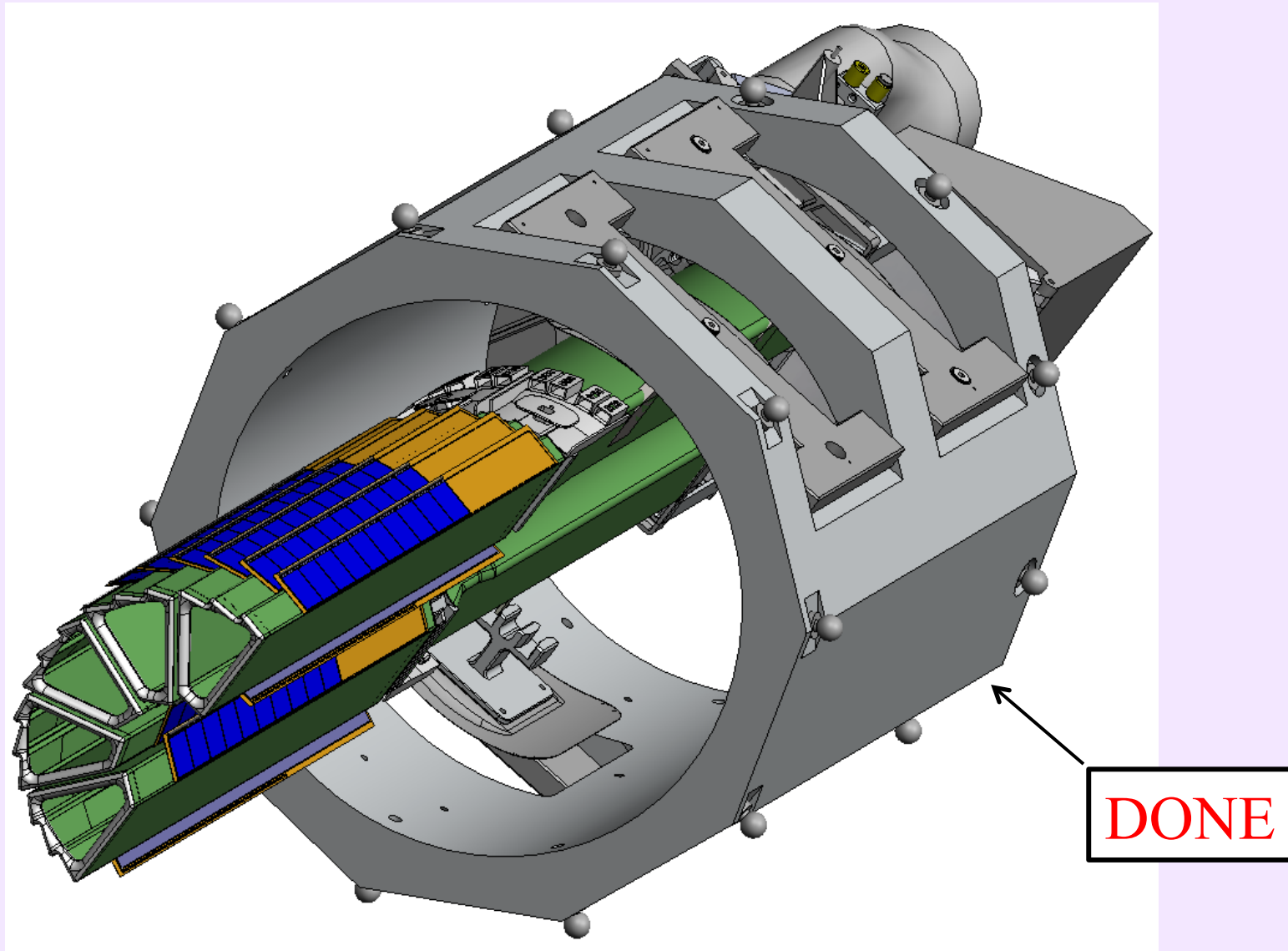

# Partial Summary

- We are getting used to the CMM data and Survey process
- Very soon we will have a realistic playground for software
- Manpower looks O.K. for the task

# Simulation Updates

$$B \rightarrow J/\psi + K \rightarrow (\mu+\mu) + K$$

- Idea: trigger on  $J/\psi$  muons with the MTD
- Production with HFT+MTD done
- QA of  $B \rightarrow J/\psi + X$  embedding done
  - <http://drupal.star.bnl.gov/STAR/event/2010/09/03/hft-software/qa-mtd-b-jpsi-muons>
- work in progress

# Reconstructed $p_T$ vs. Simulated $p_T$ of daughter $\mu^\pm$

No pseudorapidity cut, no primary vertex cut, no dca cut

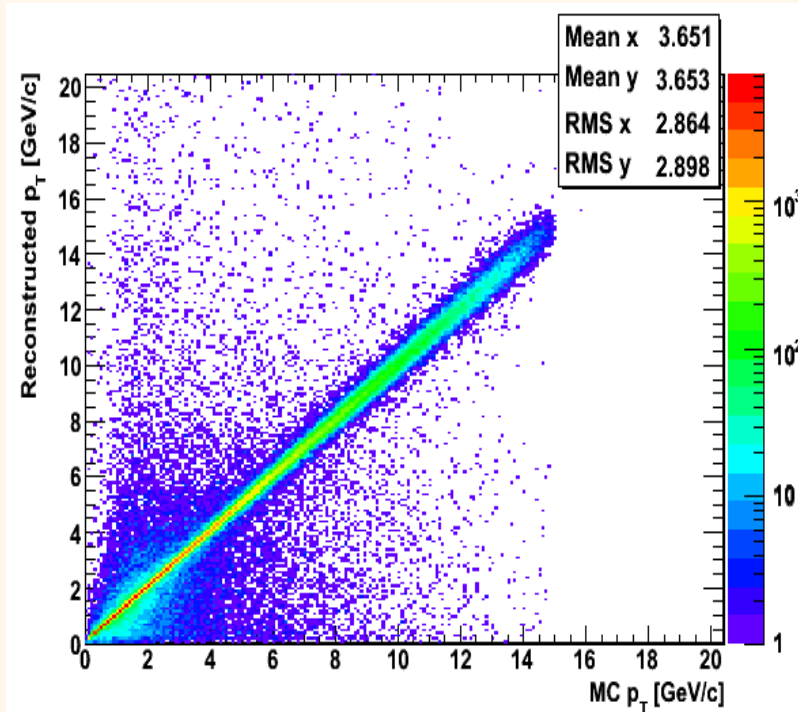

# Reconstructed Invariant mass for all pairs of reconstructed tracks with (Monte-Carlo) TOF cut of 10 ps of expected TOF (for muon mass)

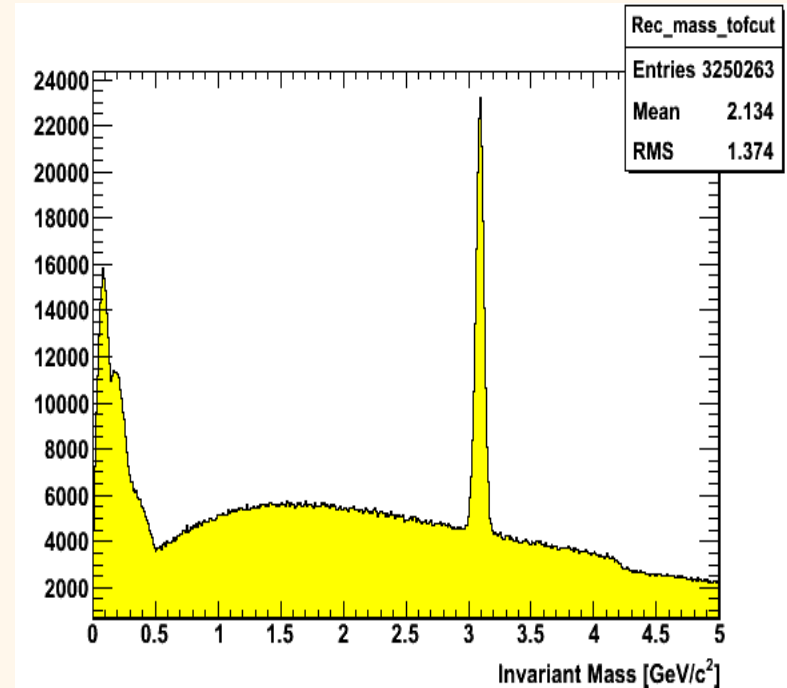

Roughly 90% of simulated daughter muons are reconstructed

# $D_s \rightarrow \Phi + \pi \rightarrow KK\pi$

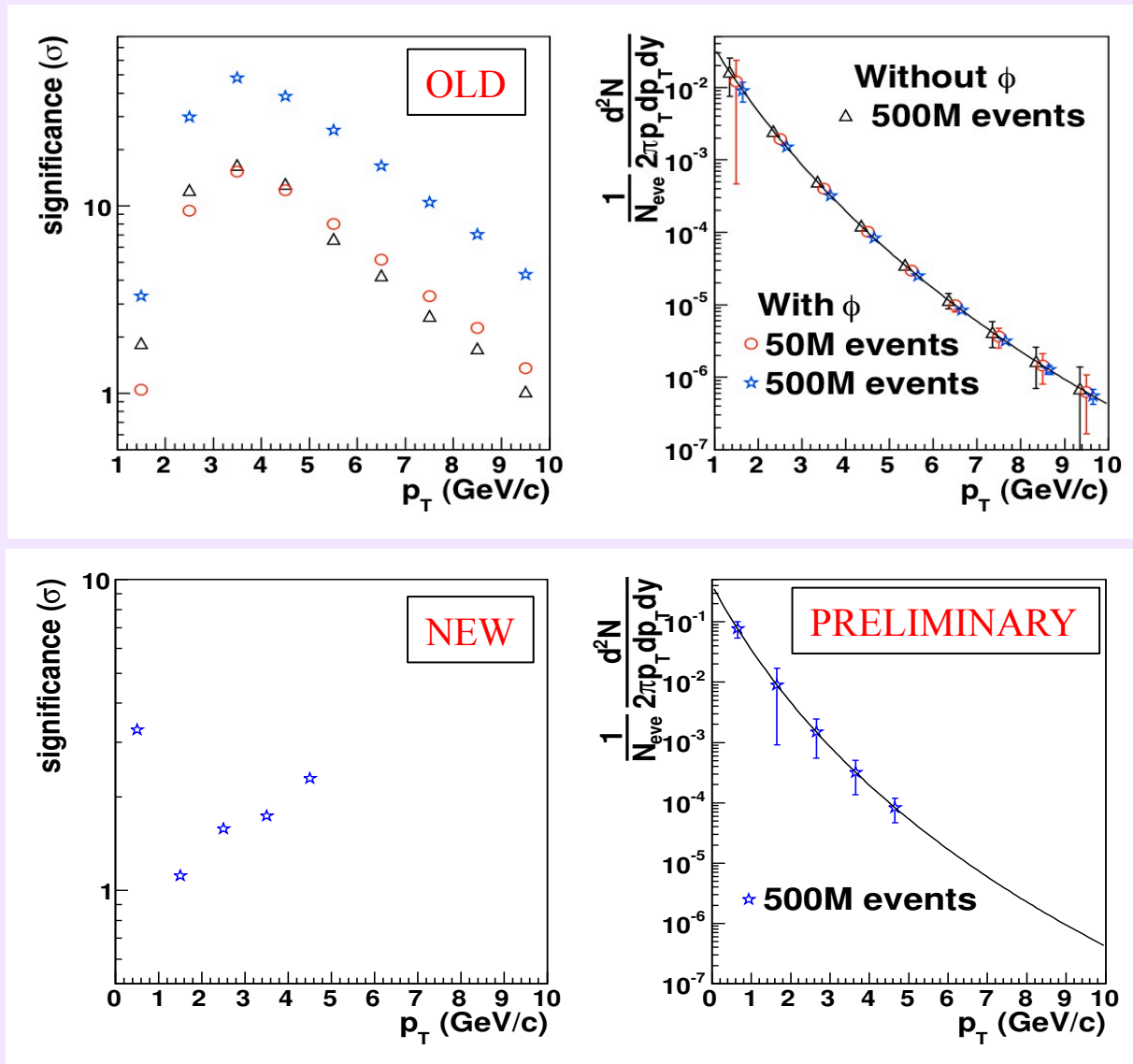

FIG. 1: The simulation results of the  $D_s$  reconstruction from  $D_s \rightarrow \phi + \pi \rightarrow K^+ + K^- + \pi$  decay channel.

- New result **too fresh** to understand and digest
- New efficiency 10 smaller than old
  - what new ‘reality’ went into it?
- work in progress



- Jonathan continues working on his Kalman paradigm on the 3-body decay of  $D^+$
- Production files with standard PXL were located. He used 5 Kevents initially.
- Looked at  $D^0$  and  $D^+$
- InvMass peaks started showing

### Need

- Optimization for  $D^+$
- Apples to apples comparison (as much as possible) of  $D^0$  efficiencies with non-fitting methods (eg Yifei)

# $D^0 \rightarrow K\pi$

$L/dL > 6$

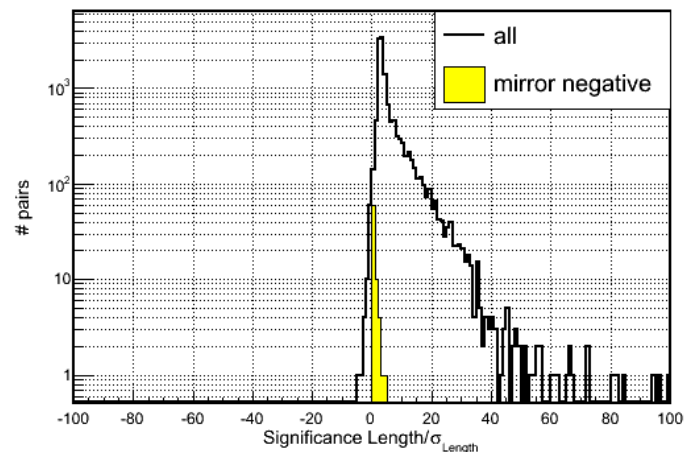
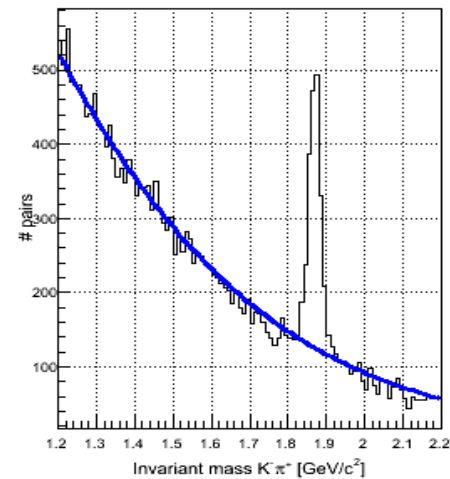
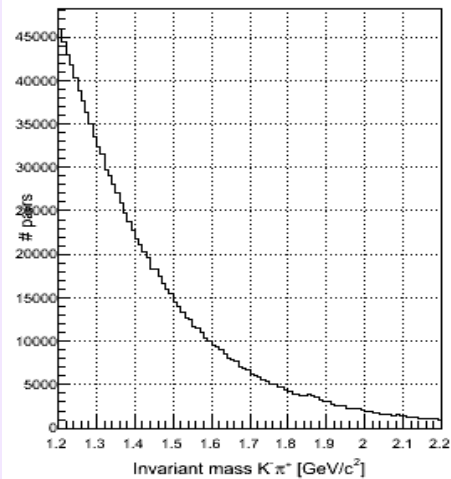
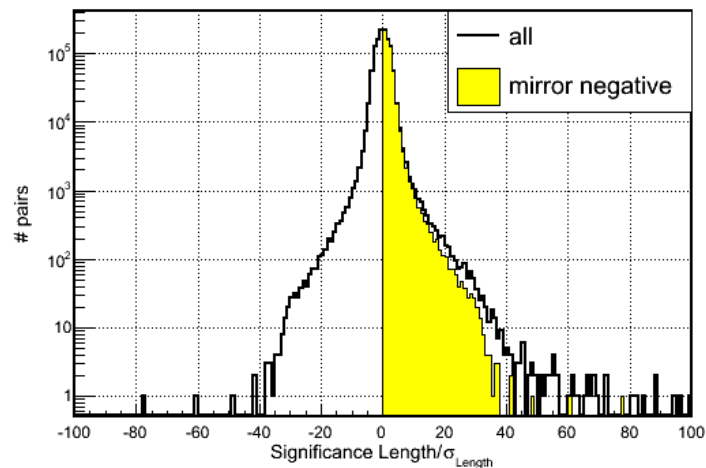

CDR cuts

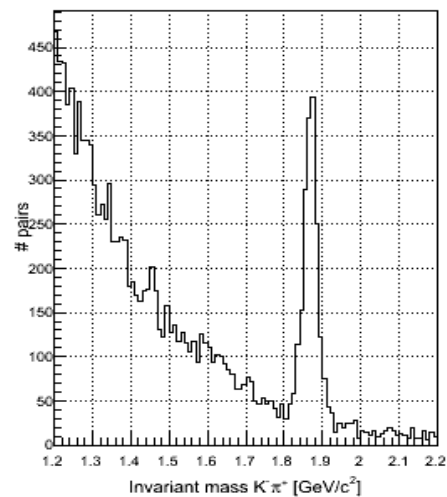

+  $L/dL > 6$

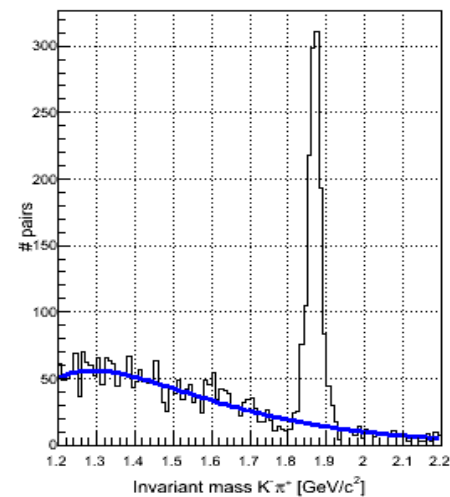

$D^+ \rightarrow K\pi\pi$

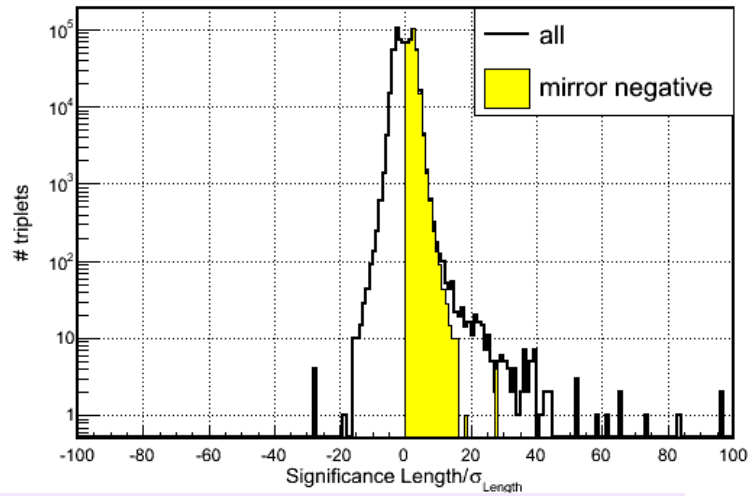

No cuts

$L/\sigma_L > 6$  && pixHits=2

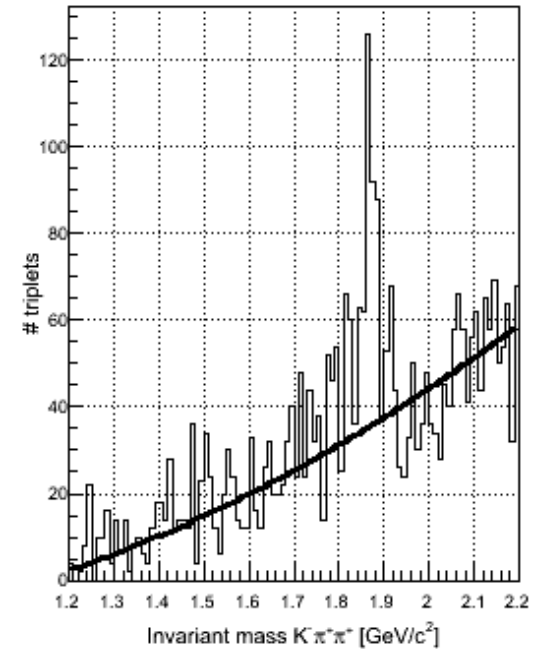
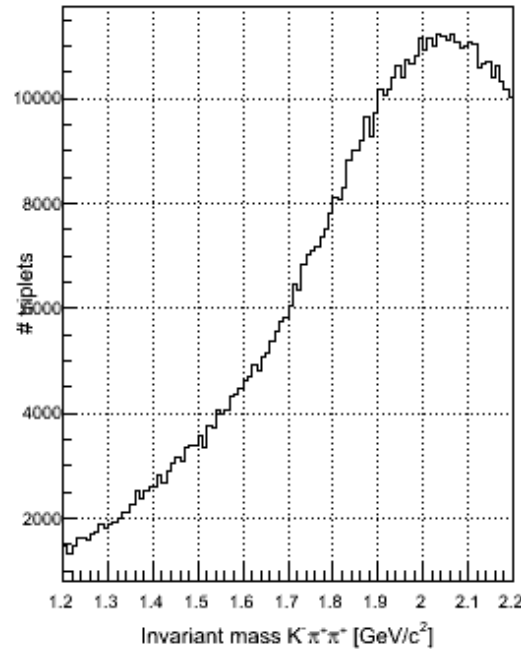

- In these plots, I **JUST** required PixelHits = 2 +  $L/dL > 6$



## Background shape restored (pt cut effect)

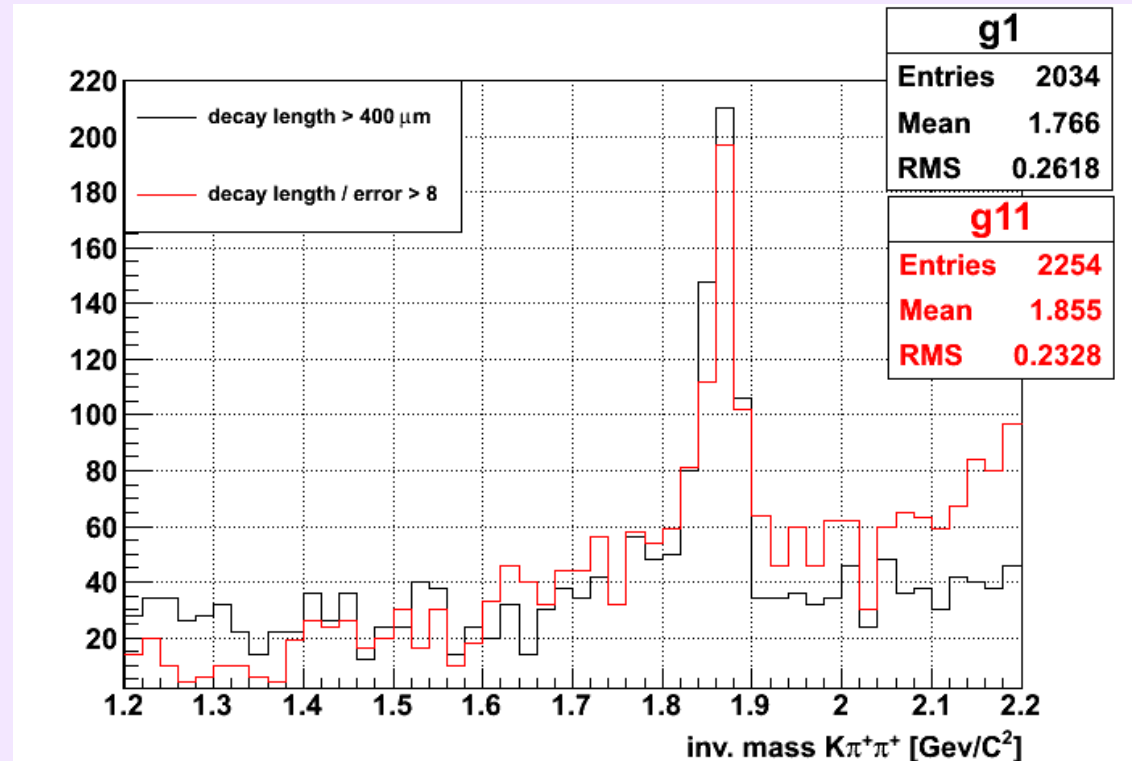
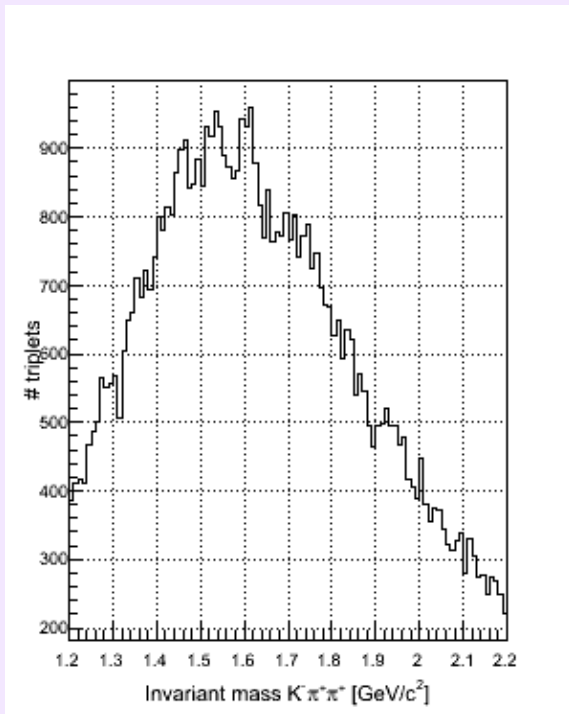

- Assuming a decay length error  $\sim 25$  microns, a fixed decay length  $> 400$  microns would lead to a decay length /error cut equal to 16.
- This idea of this plot is to show that a cut based on the decay length significance (instead of decay length) may be better
- Note : The advantage of the (Kalman) Fitter method is that it is unbiased in pt

# $\Lambda_c \rightarrow K\pi$

## $\Lambda_c$ reconstruction via $K^- + \pi^+ + p$ decays

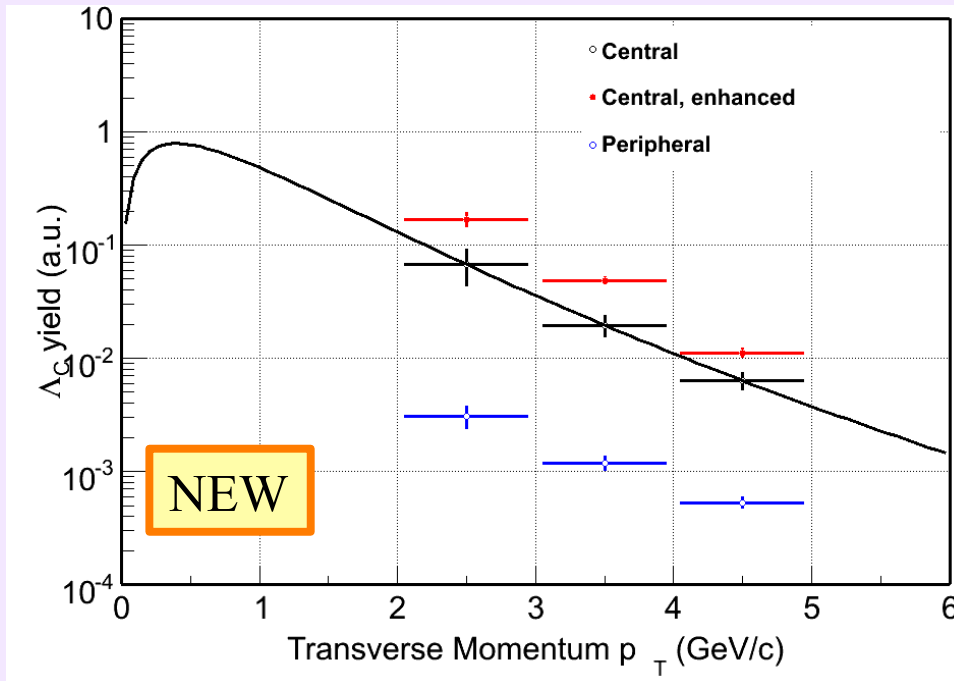

The presented simulation analysis of  $\Lambda_c$  reconstruction in Au+Au collisions uses 20k simulated central (roughly 0-10% most central) HIJING collisions, with 18  $\Lambda_c$  inserted in each event with flat  $p_T$ . All simulated  $\Lambda_c$  were forced to decay in the most interesting hadronic channel  $\Lambda_c \rightarrow K^- + \pi^+ + p$  (B.R. 5.0%). The  $cr$  for  $\Lambda_c$  is only 59.9  $\mu\text{m}$ , which makes it a challenging measurement even with HFT. The simulation uses the most recent geometry of STAR with HFT (so-called upgr15).

The reconstructed signal was rescaled to the realistic scenario, which is the power-law with  $\langle p_T \rangle = 1.0$  GeV/c and  $n = 11$ . The expect yield of  $\Lambda_c$  per binary collision is  $dN/dy = 0.0004$ , which is 20% of the  $D^0$  yield measured by STAR. A scenario of  $\Lambda_c/D^0$  enhancement similar to the one of  $\Lambda/K$  was also considered. We also made a simple rescaling for peripheral (60-80% most central) collisions, where signal was expected to follow  $R_{CP}$  of charged hadrons as measured by STAR and background tracks expected to scale with  $N_{part}$ .

Candidate triplets were constructed and several cuts were applied. The effort in cut tuning was to maximize signal significance  $S/\sqrt{S+B}$ . Triplet invariant mass was cut at  $2-\sigma$  to maximize the significance. The analysis assumed 90% efficiency of Time Of Flight (TOF) detector and its ability for  $K-\pi$  separation for  $p_T < 1.6$  GeV/c and  $(K+\pi)-p$  separation for  $p_T < 3.0$  GeV/c. For lower  $p_T$  bins of reconstructed  $\Lambda_c$  ( $p_T < 4$  GeV/c, all daughter tracks were required to be identified, while for  $p_T > 4$  GeV/c misidentified tracks were allowed into the analysis.

Distance of closest approach (DCA) of daughter tracks to reconstructed decay vertex was cut at  $2\sigma$ , where  $\sigma$  is the track DCA resolution (a function of track PID and  $p_T$ ). Two other cuts ( $\cos\theta$  and track DCA to primary vertex) were automatically optimized to maximize significance. The cut optimization was performed separately for the cases of central collisions, enhanced central collisions and peripheral collisions in 3  $p_T$  bins.

Figure 1 shows the ratio of  $R_{CP}$  for  $\Lambda_c$  and  $D^0$  from 500M central and 500M peripheral events (which may be taken as 250M central-triggered and 2000M minimum-bias-triggered events). Note that the errors are statistical and errors coming from  $D^0$  reconstruction can be neglected for it much bigger  $cr$ , 2-particle decay mode and higher yield.

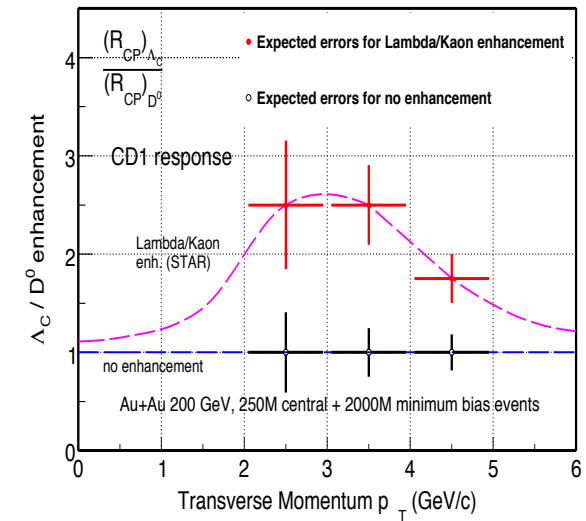

FIG. 1: Estimated performance of HFT detector demonstrated at its ability to measure a possible  $\Lambda_c/D^0$  enhancement

- Pt spectra of  $\Lambda_c$  (left)
- Documenting already-done work (right)

# WBS (more) detailed task list

## 1.6 Software

The Software deliverables contain all software modules necessary to produce physics results. The tools are divided into two broad categories: Online and Offline. The modules needed will monitor, calibrate, reconstruct, analyze and evaluate the acquired data samples.

### 1.6.1 Online

The online software primarily ensures the data integrity during data acquisition via appropriate detector monitoring and sample event reconstruction. Online software is detector specific and is a deliverable of the corresponding sub-system.

### 1.6.2 Offline

The offline environment consists of the event reconstruction software packages. This starts with the raw data as input and through proper calibrations it proceeds with detector cluster/hit finding, integrated tracking, event-vertex and secondary-vertex finding and event information writing on DSTs.

### Hit Reconstruction

The Cluster/Hit finder is the first piece of code applied to the pedestal subtracted raw information from the IST and PXL detectors and its task is to deliver reconstructed space points to tracking software. The software modules associated with this task are outlined below (grouped by detector):

**1) SSD:** The SSD is an existing (refurbished) detector in STAR. Its behavior is well understood and there are hit reconstruction modules already in place. The only software tasks left are dead-strip mapping (a calibration/Db issue) and the update/testing of the hit finder routine with the new configuration. We also list here an unfinished/untested single-side hit finder as a prospective hit-finder update provided the manpower to finish it.

1.1 Test/Certify/Update the existing SSD cluster/hit finder with the new configuration. 0.5 FTE for a period of 6(2) months is needed for this task completion.

1.2 Test/Evaluate the single-side hit finder based on the Root function TSpectrum initiated by BNL/Nantes. 0.5 FTE for a period of 6(2) months is needed for this task completion. The deliverable would be a replacement cluster/hit finder for the SSD and perhaps the IST.

Institutions responsible: [KSU, BNL, other]

**2) IST:** The IST hit finder can either be a modified version of the SSD one (since the

- An initial release of an 11 pages document is done
- Some feedback was received (a couple of institutions) on specific interest
- Task list calls for software contact persons. e.g.
- SSD software contact: Jonathan, but who is the survey skilled contact to interface with software.
- Same for IST, PXL.

Software task		BNL	UCLA	KSU	NPI	MIT	LBL	Purdue	
<b>Offline</b>									
Hit Reconst.	IST					X			
	Pixel						X	X	?
Tracking		X							?
Event Vertex		X		X	X				
Decay Vertex		X		X	X				
Calibration Db	IST					X			?
	PXL						X	X	
Alignment	IST	X		X		X			
	PXL	X		X			X	X	
<b>Simulation</b>									
Geometry	IST	X				X			
	PXL	X					X		
Fast/Slow Sim.	IST			X		X			
	PXL						X	X	
Embed./Pileup	IST			X		X			
	PXL						X	X	
Assoc/Analysis		X		X	X				

- Needs Update (tasks)
- RMP numbers need Update and Pro-active assignments

### **FY2010 Milestones**

Q2 FY 10	Concept for HFT Calibration
Q2 FY 10	IST pre-prototype module cosmic ray test, calibrated and analyzed
Q2 FY 10	Pad Monitor functioning
Q2 FY 10	Calibrate Pixel prototype
Q4 FY 10	Cosmic ray test of engineering prototype done and analyzed
Q4 FY 10	Update geometry in simulations

### **FY2011 Milestones**

Q1 FY 11	Functional Pixel Calibration
Q3 FY 11	Cosmic ray test for Pixel prototype and SSD performed and analyzed
Q4 FY 11	Tracker/Vertex finders upgraded/tuned/ debugged
Q4 FY 11	IST prototype module cosmic ray test
Q4 FY 11	Calibration Databases finalized

- Our RMP Milestone schedule is badly outdated
- For a more realistic one I need updated Sub-detector schedules
- I definitely need input from Sarah and help from Flemming

## 'To Do' until CD2/CD3

- Refresh/Update simulation work with emphasis on New/Expanded capabilities
  - B-mesons, D+, Ds, ... $\Lambda_c$ , D<sup>0</sup> etc
- Finalize WBS detailed task-list
  - with Updated Institutional commitments
- Work on a realistic schedule/milestones in coordination with Sub-systems time-lines
  - we assume there are no risks associated with software
- Work on PXL survey/calibration

# Content slide instead of a Summary

- HFT-Physics PR
- Some notes on PXL Alignment procedure
  - Structures, fits, some results <- in progress, needs effort
- Simulations Updates, getting ready for CD2/3 : In progress
  - $B \rightarrow J/\Psi$  <- critical
  - $D_s \rightarrow \Phi + \pi \rightarrow KK\pi$
  - $D^+ \rightarrow K\pi\pi$
  - Other
- Progress on WBS. Schedule and Resources need work